

POLYCAB

CONNECTING TO A  
GREENER SAFER &  
BRIGHTER FUTURE





# INDEX

1	About Polycab.....	03
2	Cables and Wires.....	11
3	Dowells.....	32
4	Cables Trays.....	37
5	Conduits.....	43
6	Switches.....	53
7	Switchgears.....	67
8	Professional Lighting.....	82
9	Fans.....	106
10	Solar.....	112





Polycab India Limited (PIL) is India's largest manufacturer of Wires and Cables and one of the fastest growing FMEG companies with a consolidated turnover of ₹180+ Bn in FY24. PIL is at the forefront of providing innovative, safe and energy efficient products to a diverse set of customers via a strong distribution network of 3,800+ authorized dealers and 205,000+ retail outlets. PIL's business operations span across India through 28 manufacturing facilities, 13 offices and 29 warehouses. PIL has also served customers in 79 countries globally. PIL's 4,800+ employees are dedicated to upholding robust governance practices, preserving a customer centric culture, having a purpose to serve the communities, and imbibing a genuine sense of ecological consciousness. For further information, please visit [www.polycab.com](http://www.polycab.com).

# ABOUT POLYCAB



**No.1**  
MANUFACTURER OF  
CABLES AND  
WIRES IN INDIA



**28**  
STATE-OF-THE-ART  
MANUFACTURING  
FACILITIES

## MANUFACTURING CAPACITY\*

• 6 MILLION KM OF CABLES • 9 MILLION FANS  
• 24 MILLION SWITCHGEARS • 12 MILLION SWITCHES



500+ Service Centres  
Across India



World-class Design and  
Development Centre



Export Presence In  
79 Countries



NABL ISO 17025  
Certified R&D Centre



In-house Software and  
Hardware Development Centre

# Our Strength



Manufacturing  
excellence



In house  
design expertise



NABL  
accredited lab



Technology oriented



End-to-end solution



Customer centric

# Our national presence

---

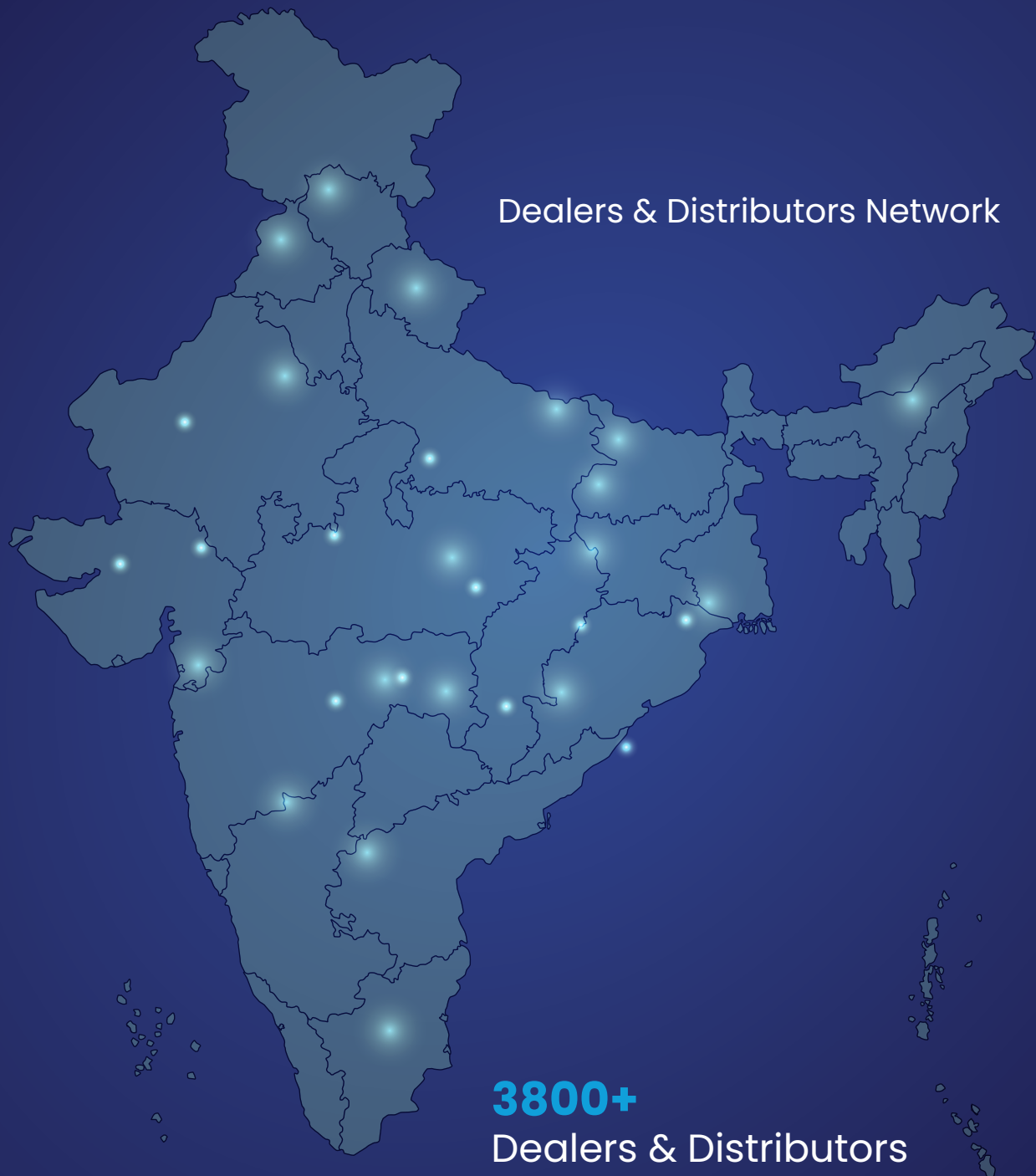

# Our global presence

Connecting Lives in  
**79 Countries**



## PROFESSIONAL LIGHTING



## CONDUITS



## WIRES

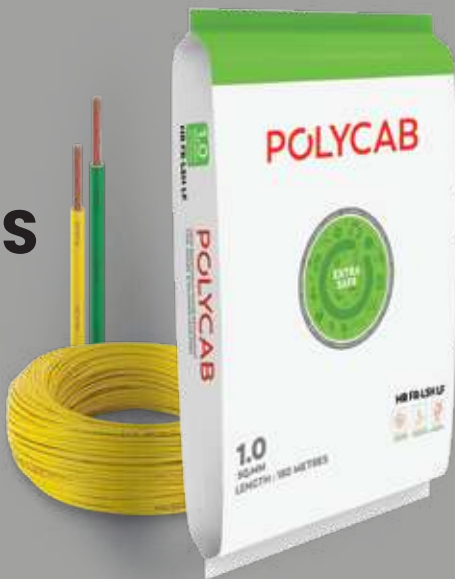

## SOLAR

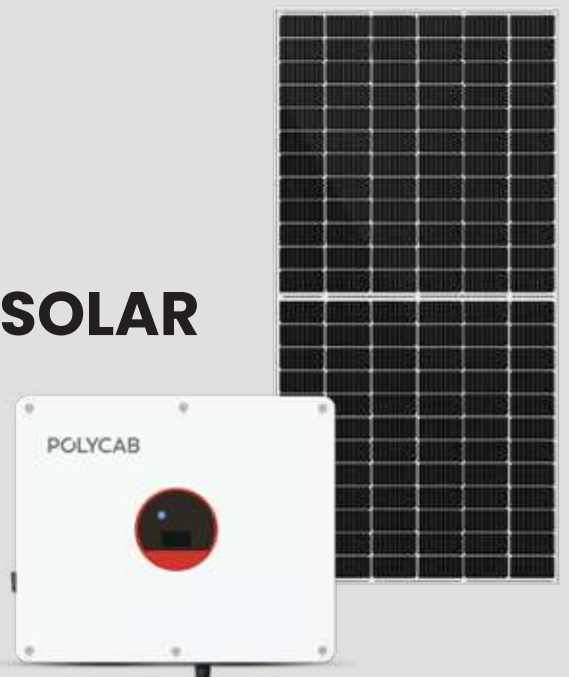

## DOWELLS



## FANS



## SWITCHGEAR



## CABLES



## CABLE TRAYS

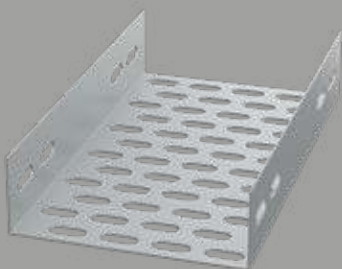

## SWITCHES



# CABLES & WIRES

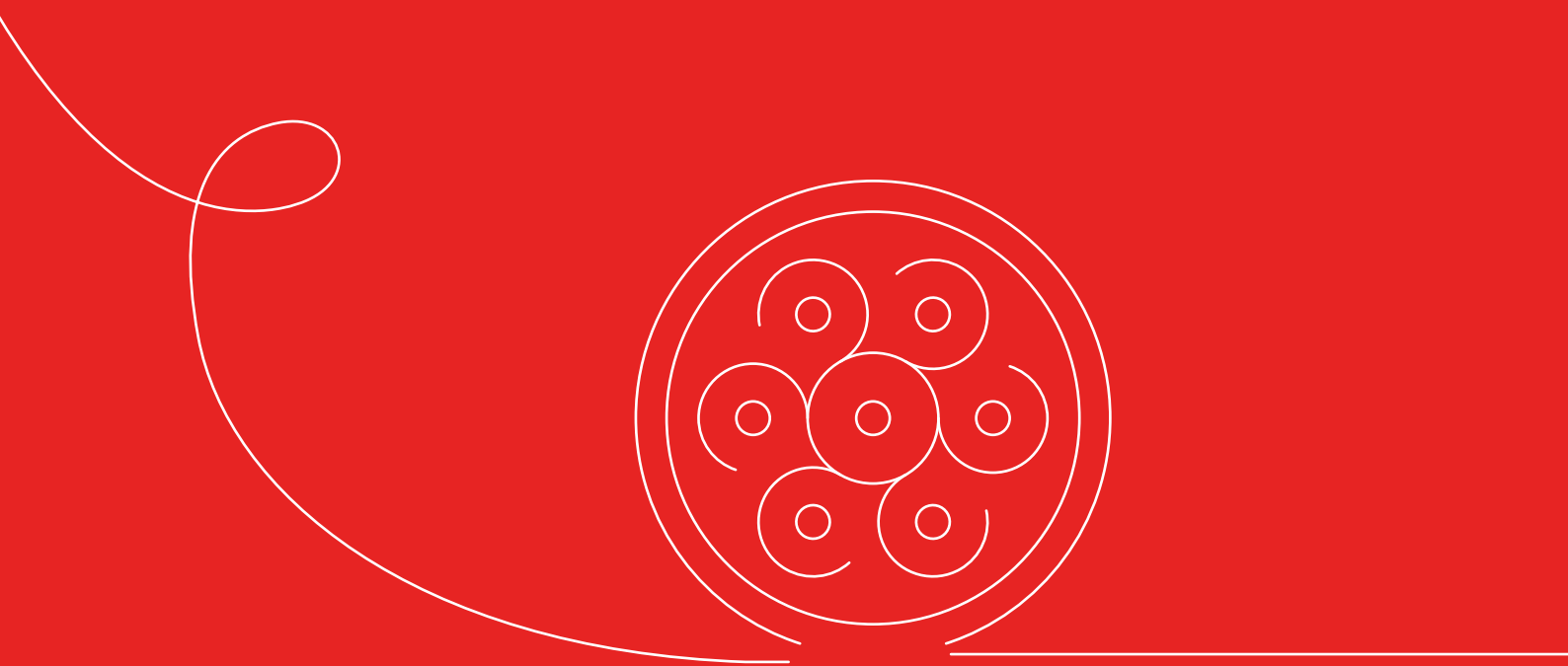



# EHV CABLE

POLYCAB

## EHV POWER CABLES

Single Core Copper / Aluminium Conductor, Semi-conducting tape, Conductor screened with Extruded Semi-conducting compound, XLPE insulated, Insulation screened with Extruded Semi-conducting compound, Semi-conducting Water blocking tape, Copper Screen + Semi-conducting Water Blocking Tape / + Poly-Aluminium Laminated / + Extruded Metallic Lead Sheath / Corrugated Aluminium Sheath, Extruded High-density Polyethylene Outer Sheathed cables generally conforming to IS 7098-3 / IEC 60840 / IEC 62067 / ICEA S-108-720.



# MV CABLE

## MV POWER CABLES

Single Core / Three Core Copper / Aluminium Conductor, Conductor Screened with Extruded Semi-conducting compound, XLPE/EPR Insulated, Insulation Screened with semi-conducting compound in combination with copper wire / copper tape / Plain WS Tape / PE ST7 PVC ST2 / FR / FRLS / LSZH inner sheathed, Unarmoured / GI Steel (Aluminium in case of Single Core) flat / round armoured, and overall PE/PVC ST2 / FR / FRLS / LSZH Sheathed cable conforming to IS 7098-II 2016, IEC 60502-2, BS 6622 / BS 7835 / BS 7870-4-10 / BS 7870-4-20 / BS 5467 / BS 6724 / AS-NZS 1429.1 / ICEA S-93-639 (NEMA WC-74) from sizes 35 sq. mm to 1200 sq. mm. These cables can be supplied with lead sheath wherever required.



# LV POWER CABLE

## LV POWER CABLES

1100 Volts grade – BASEC/KEMA/(CPRI/ERDA Tested) Copper / Aluminium Power Cables, Solid / Stranded Conductor, PVC / XLPE Insulated, cores laid up, PVC / FR / FRLS / LSZH/PVC ST2 innersheath, Unarmoured/Armoured, extruded PVC / FR / ST2 / FRLS / LSZH sheathed cables from 1.5 sq.mm to 1000 sq.mm in 1/2/3/3.5/4 core as per IS 1554-1 / IS 7098 (Part 1) 1988/BS 5467 / BS 6724/IEC 60502-1. Above cables can be supplied with lead sheath wherever required.



# INSTRUMENTATION CABLE

POLYCAB

CABLE & WIRES

DOWELLS

CABLE TRAYS

CONDUITS

SWITCHES

SWITCHGEARS

PROFESSIONAL LIGHTING

FANS

SOLAR

## INSTRUMENTATION CABLE

Solid / Stranded / Flexible Copper Conductor, PE / XLPE / PVC / XLPO / EPR / Silicone Rubber insulated, Pair / Triad / Quad, Individually / Overall Aluminium Mylar + Drain wire / Copper wire braid / Copper Taped, PE / PVC (HR / FR / FRLS) / Rubber / LSOH Inner Sheathed, Unarmoured / GI Armoured, PE / HDPE / PVC (HR / FR / FRLS) / LSOH / Rubber Outer Sheathed Instrumentation cables generally conforming to IS 1554 / 7098 Pt-1 / BS EN 50288-7. Above cables can be supplied with Lead Alloy / Polyamide Metallic Barrier Sheath wherever required.



## VARIABLE FREQUENCY DRIVE (VFD) CABLE

3+3(E) / 4 Core Flexible copper conductor, insulated with XLPE / PE / PP, laid up, Al. Mylar with tinned copper wire braided, PVC sheathed cables generally conforming to IS 7098-1, IEC 60502-1.

## THERMOCOUPLE CABLE

Solid JX / KX Thermocouple alloys, XLPE / PVC insulated, Individual / overall Al. Mylar tape + Drain wire shielded, Inner sheathed, Armoured / Unarmoured, flame and sunlight resistant PVC outer sheathed cable conforming to EN 50288-7.



# RENEWABLE ENERGY CABLE

POLYCAB

## WINDMILL CABLE

Annealed Bare / Tinned Copper conductor, conductor screen as required, PVC / Heat resistant / XLPE / EPR insulated, insulation screen as required, cores / pairs laid up, inner sheathed as required, metallic screened as required and PVC / heat-resistant / TPE / CPE outer sheathed torsion resistant / power / control cables voltage grade 0.6/1kV to 3/36 kV conforming to IEC 60502-1, IEC 60502-2, IS 9968-1, IS 9968-2, BSEN- 50525-2-41, BSEN 50525-2-21, BSEN 50525-2-83.



## SOLAR DC STRING CABLE BS EN 50618, IEC 62930 & AS NZS 5000.1

Photovoltaic Solar DC Cable, Flexible copper conductor, Electron beam cross linked, halogen free, flame retardant, low smoke insulation & outer sheath with anti termite property single core cable is designed for use in Photovoltaic installation on DC side. These cables are suitable for permanent outdoor use under variable climatic condition.

## SOLAR H1Z2Z2 -K BS EN 50618 - TWIN

Photovoltaic Solar DC Cable

POLYCAB low smoke, halogen free, flexible twin flat parallel cable with electron beam cross linked insulation and sheath is designed to use for Photovoltaic installation at the DC side. These cables are suitable for permanent outdoor use under variable climatic condition.



## SOLAR UL 4703 – AL ALLOY

Photovoltaic Wire, Halogen free, Flame Retardant.

POLYCAB PV halogen free flame-retardant Al Alloy conductor E-Beam crosslinked Polyolefins insulated Wire is designed to use in Outdoor Solar application as per UL 4703/NEC 690 in wet & dry location. The cable is rated direct burial, Sunlight resistant and weatherproof.

**SOLAR HALOGEN FREE LOW SMOKE IEC 62930**

Photovoltaic Solar DC Cable, Halogen Free, Flame Retardant  
POLYCAB low smoke, halogen free, flexible single core cable with electron beam cross linked insulation and sheathing is designed for use in Photovoltaic installation on DC side. These cables are suitable for permanent outdoor use under variable climatic condition.



**SOLAR DC FEEDER CABLE AS NZS 5000.1 – ANTI TERMITE**

Photovoltaic DC Feeder Cable  
POLYCAB, single core cable with cross linked polyethylene insulation is designed to use for Photovoltaic installation at the DC side. These cables are suitable for permanent outdoor use under variable climatic condition.

**SOLAR IEC 60502 -2 MV XLPE (RH5Z1-OL)**

Photovoltaic MV Cable.  
POLYCAB, single core cable with cross linked insulation is designed to use for Photovoltaic installation. These cables are suitable for direct burial application.





## SOLAR AS NZS 1429 MV XLPE

Photovoltaic MV Cable

POLYCAB, single core cable with cross linked insulation is designed to use for Photovoltaic installation. These cables are suitable for direct burial application.

## SOLAR UL 1072 MV 105 TR - XLPE

Photovoltaic MV Cable

POLYCAB, single core cable with Tree Retardant cross linked Polyethylene insulation is designed to use for Photovoltaic installation. These cables are intended for use in wet or dry locations for distribution of single or three phase medium-voltage power. These cables may be installed in ducts or direct buried.



## SOLAR UL 1072 MV 90 TR -XLPE

Photovoltaic AC Cable

POLYCAB, single core cable with Tree Retardant cross linked Polyethylene insulation is designed to use for Photovoltaic installation. These cables are intended for use in wet or dry locations for distribution of single or three phase medium-voltage power. These cables may be installed in ducts or direct buried.



# COMMUNICATION & DATA CABLE

POLYCAB

CABLE & WIRES

DOWELLS

CABLE TRAYS

CONDUITS

SWITCHES

SWITCHGEARS

PROFESSIONAL LIGHTING

FANS

SOLAR

## OFC CABLE (OPTICAL FIBRE CABLE)

Light in motion, that is how we define our Optical Fiber division. A state of the art manufacturing unit duly supported by our skilled and highly expert team. Polycab is working closely with the Government of India projects such as Digital India, Make in India, BharatNet, SmartCities for a better and futuristic India.



## DATA CABLE

Annealed Flexible Copper conductor, Polyethylene insulated, laid up cores, Annealed Tinned Copper Braided, PVC outer sheathed RS485, LIYY, LIYCY, Data Cable. (other type of Data cables per customised design / standards available on demand).

## SPEAKER CABLES

Range: Twin Parallel 23 / 36, 23 / 38, 40 / 36 and 40 / 38 – Polycab provides Speaker Cables with high quality oxygen free copper conductor ensuring excellent sound quality for your expensive Sound system. Selecting the right gauge, length, and type of speaker wire for your system helps avoiding mismatch with your music system.

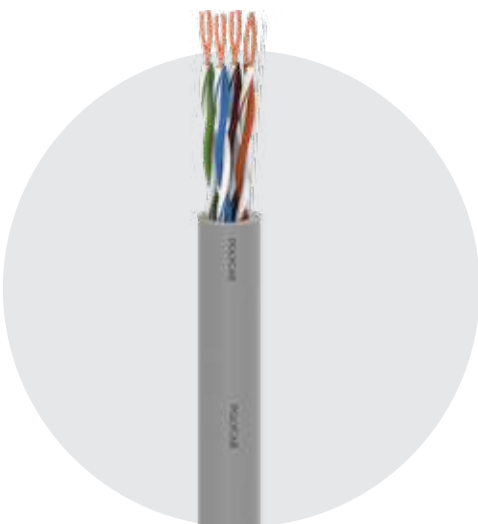
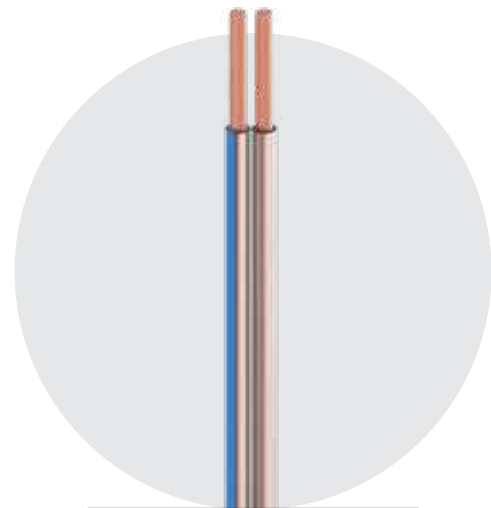

## LAN CABLES

Range: Cat 5e, Cat 6 & Cat6a – Twisted Pair, Insulated with High Quality Polyethylene and Unshielded Light Grey PVC Jacket with Improved Fire Retardant properties, Low attenuation and improved crosstalk and Low Structural return loss.

## COAXIAL CABLE

RG 59 F, RG 6 F & RG 11 F with copper/ CCS conductor, nitrogen gas injected polyethylene foam insulated, bonded aluminium foil laminated, al-alloy braided, water resistant jelly flooded, weather resistant PVC sheathed, 75Ω low loss coaxial cable for DTH and CATV application.

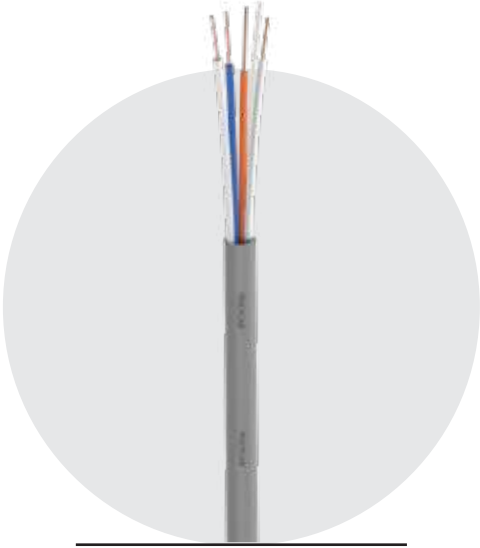
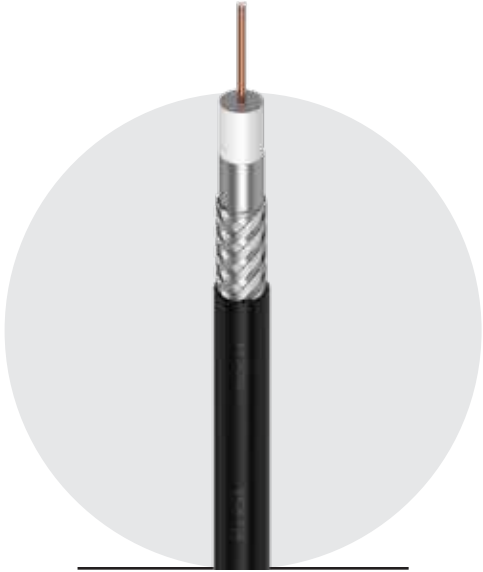

## TELEPHONE CABLE

0.40 mm / 0.50 mm solid bare copper conductor, HDPE insulated, core twisted to form pair, flame retardant jacketed, 1 pair to 100 pair, switchboard / telephone cable for EPBAX application.

## CCTV CABLE

0.5 mm Annealed Bare Copper conductor, HDPE insulated, 3 or 4 power cores + 0.82 mm Solid Bare Copper, physically foamed HDPE insulated RG59F cable, collectively laid up in (3+1) or (4+1) formation, PVC jacketed CCTV cable for building security application.

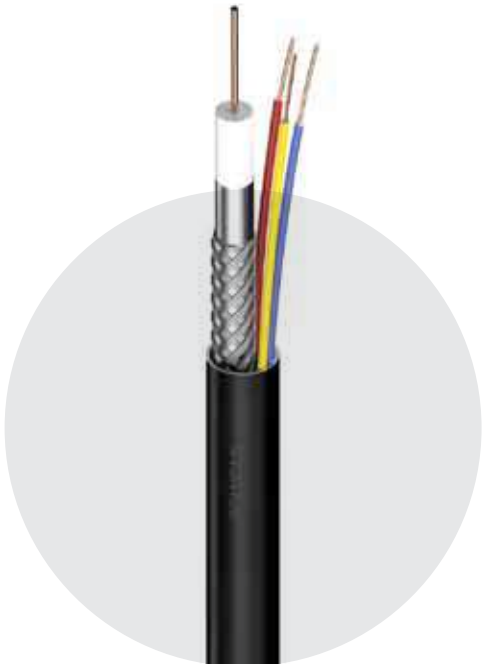

# FIRE PROTECTION CABLES

POLYCAB

CABLE & WIRES

DOWELLS

CABLE TRAYS

CONDUITS

SWITCHES

SWITCHGEARS

PROFESSIONAL LIGHTING

FANS

SOLAR

## FIRE SURVIVAL CABLES

LPCB approved BRE Global tested Stranded Copper Conductor covered with layers of Mica Glass Tape, XLPE / EPR / Silicon / FR-XLPE / XLPO insulated, cores twisted to form pairs and individual shielded / overall shielded with Al. Mylar Tape along with ATC drain wire (for pair / control cables as required), extruded FRLS / LSOH inner sheath (as required), Unarmoured / GI Steel / Copper braid (Aluminium in case of single core) Armoured, extruded FRLS / LSOH Outer sheathed Fire Survival Cables generally conforming to IEC 60331, BS 7846, BS 7629-1, BS 8592, BS 7211, BS 6724, IEC 60502-1, BS EN 50288-7, BS 6387 Cat. CWZ, BS EN 50200 (PH 30/60/120), BS 8434, BS 8491, IS 17505.

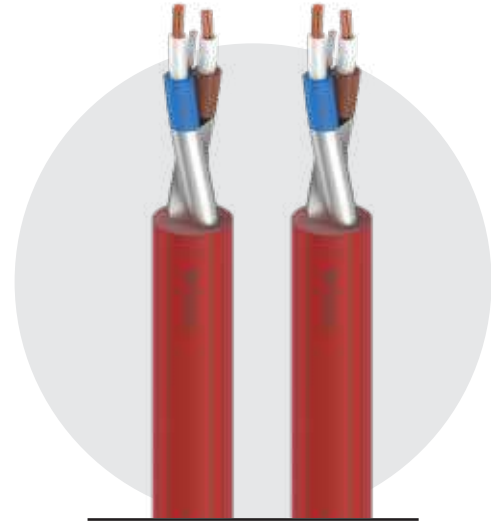

# HIGH TEMPERATURE CABLE

## HIGH TEMPERATURE CABLE

Single / Multicore, Annealed Tinned Copper Conductor, EPR / Silicone Rubber Insulated, laid up, proofed cotton taped, CPE / PCP / CSP / Silicone Rubber sheathed Flexible cables, upto 1100V grade confirming to IS 9968-1:1988.

Single / Multicore, Annealed Tinned Copper Conductor, EPR Insulated, laid up, proofed cotton reinforced laid up inner sheathed and reinforced, Heavy-duty CPE / PCP / CSP sheathed Flexible cables, upto 33kV grade generally conforming to IS 9968-2:2002.



## UNINYVIN CABLE

Annealed Tinned Flexible Copper Conductor, Thermoplastic High Temperature PVC insulated, Glass Fibre Yarn Braided + Transparent Nylon Lacquer coated, voltage grade 600V AC Uninyvin Cable.

## METRO RAIL CABLE

Single / Multicore Flexible Copper Conductor, E-beam cross-linked Flame Retardant compound / Silicone Rubber insulated suitable to temperatures of 90°C to 150°C, screened/ unshielded and sheathed with Zero Halogen compound generally conforming to BS EN 50264-3-1, 2 / BS EN 50306-2,3,4 / BS EN 50382-1,2.



## RAILWAY SIGNALLING CABLE

Single / Multicore Flexible Copper Conductor, PVC insulated, PVC Inner Sheath, GI Armoured / Steel Tape, PVC Outer Sheath conforming to RDSO Specification No. IR S-63 / 2014 & IS 1554-1.

## RAILWAY ROLLING STOCK POWER AND CONTROL CABLE

Single / Multicore Flexible Copper Conductor, E-beam Cross-linked Flame Retardant compound insulated suitable for temperatures of 125°C, screened / unshielded and Electron Beam Cross-linked Zero Halogen Flame Retardant compound conforming to RDSO Specification No. ELRS / SPEC / ELC / 0019 Rev.4, CLW / ES / 3 / 0458 Alt.E, CLW / ES / 3 / 0459 Alt.A, EDTS 132 Rev.C and equivalent specifications.



# RUBBER CABLE

POLYCAB

## RUBBER/ELASTOMERIC CABLE

Single / Multicore, Annealed Tinned Copper Conductor, EPR / Silicone Rubber Insulated, laid up, proofed cotton taped, CPE / PCP / CSP / Silicone Rubber sheathed Flexible cables, upto 1100V grade conforming to IS 9968-1:1988.

Single / Multicore, Annealed Tinned Copper Conductor, EPR Insulated, laid up, proofed cotton reinforced laid up inner sheathed and reinforced, Heavy-Duty CPE / PCP / CSP sheathed Flexible cables, upto 33kV grade generally conforming to IS 9968-2:2002.

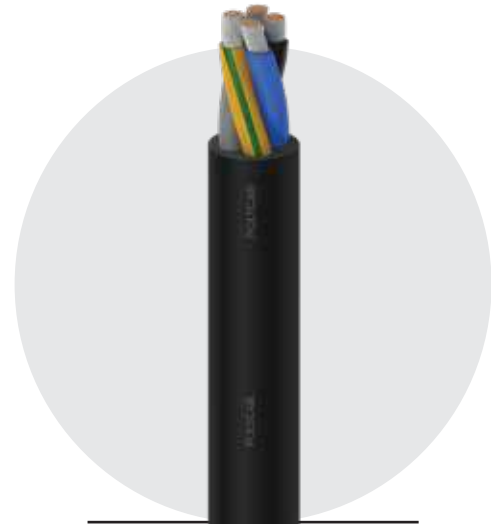

# MARINE & OFFSHORE / ONSHORE CABLE

## MARINE / SHIP WIRING CABLES

Single Core / Multicore, Annealed bare / tinned copper conductor, EPR / XLPE / Silicone Rubber / XLPO HF insulated, voltage grade 0.15 / 0.25 kV to 18 / 30 kV cables, screened / unscreened, unarmoured / metallic braid armoured, and equivalent customised design standards / specifications. PCP / CSP / HF-rubber outer sheathed cables conforming to IEC 60092-353, IEC 60092-376, IEC 60092-350, IEC 60092-360, NEK 606, BS 6883, BS 7917.



# FIRE PROTECTION CABLES

## FIRE ALARM CABLE

Annealed Copper conductor, XLPE insulated, FRLS inner sheathed, unarmoured / GI armoured, FRLS sheathed generally conforming to BS 5467. Annealed Copper conductor, XLPE insulated, Al.Mylar screened with ATC drain wire, FRLS inner sheathed, unarmoured/GI armoured, FRLS sheathed generally conforming to BS EN 50288-7.



# AUTOMOBILE CABLE

POLYCAB

## AUTOMOTIVE CABLES FOR ELECTRIC VEHICLE

Single Core / Multicore, Annealed bare / tinned copper conductor, heat resistant PVC / EBXL XLPO / Silicone Rubber insulated, 30V AC/ 60V DC to 1000V AC/ 1500V DC, temperature class 105/125/150/180deg.C, screened automotive cables conforming to ISO 19642/ ISO 6722/ Chinese Std. (GP/T QC/T) for electric vehicle application.



## CABLES FOR ELECTRIC VEHICLE CHARGER

Annealed bare copper conductor, polyolefin insulated and polyurethane sheathed 2core to 6core 450V/750V AC, 1000V DC, AC/DC charging cable conforming to EN 50620, IEC 62893, Chinese std. (GP/T QC/T) operating temp. 90 deg.C for charging of electric vehicle.

# AEROSPACE CABLE

## AIRPORT LIGHTING CABLE

Single core flexible copper conductor, TPE insulated cable generally conforming to IEC 60502-1, IEC 60227, IEC 60228/VDE 0295.



# SUBMERSIBLE CABLE

POLYCAB

## SUBMERSIBLE FLAT AND ROUND CABLES

Flat: 3 Core x 1.50 sq.mm to 95 sq.mm, Round: 3 Core and 4 Core x 1.5 sq.mm to 120 sq.mm in Class 5 copper conductors with PVC/XLPE Insulation and PVC / PVC ST2 sheathing properties.

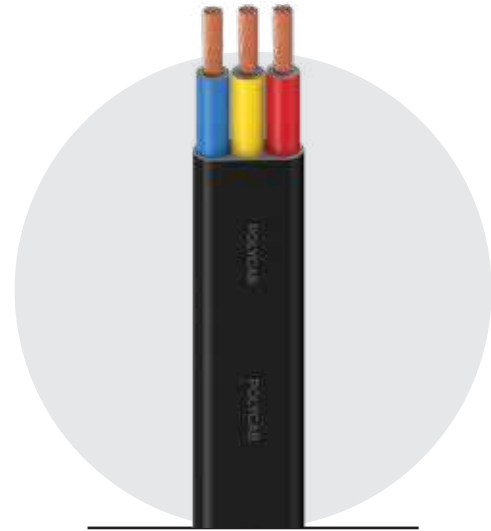
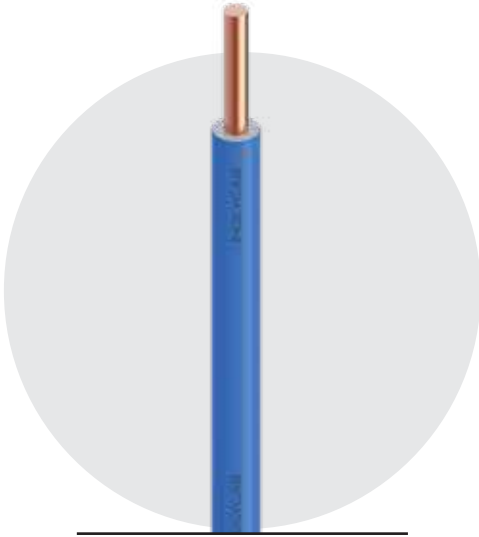

## WINDING WIRE FOR SUBMERSIBLE PUMPS

Plain annealed Solid copper conductor, PVC insulated, winding wire conforming to IS 8783:1995

## LT CONTROL CABLES

1100 Volts grade – BASEC / KEMA / (CPRI / ERDA Tested) Control Copper Cables, Solid / Stranded Conductor, PVC / XLPE Insulated, cores laid up, PVC ST2 / FR / ST2 / FRLS / LSZH extruded inner sheath. Unarmoured / Armoured Strip / Round wire, Extruded PVC ST2 / FR / FRLS / LSZH sheathed cables from 2 to 100 Core in 1.5 and 2.5 sq. mm as per IS 1554 / IS 7098 (PART 1) 1988 and generally conforming to IEC 60502-1 / BS 5467 / BS 6724 / BS EN 50288. Metallic screened control cable also available on demand.

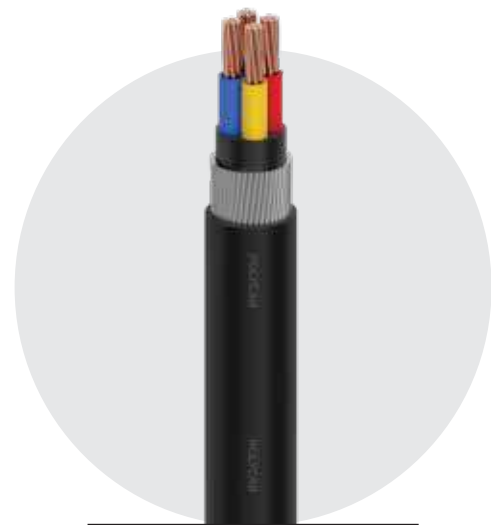

## HT AERIAL BUNCH CABLE

Stranded compacted aluminium conductor, conductor screened by semi-conducting compound, XLPE insulated, insulation screened by semi-conducting compound & copper tape, PVC sheathed, and messenger conductor with or without insulation as per the requirement generally conforming to IS 14255.

## FESTOON CABLE

Multicore Flexible Copper Conductor, PVC insulated and PVC Sheathed Flat Flexible cable of 650 / 1100V grade, developed in-house of 650 / 1100V grade, generally conforming to IS 694:2010 for crane, hoist and lift operation.

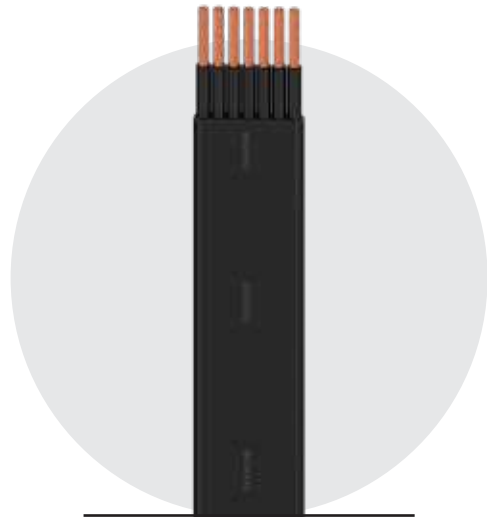

## MINING CABLE

Annealed Tinned Bunched Copper, EPR insulated Power Core and Pilot Core, Annealed Tinned Bare Copper Earth conductor, Power and Pilot core screened with composite braiding of Tinned Copper and Nylon Yarn, overall Heavy Duty Elastomeric Sheathed of type FT-1, FT-2, FT-3, FT-4(S), FT-6(S), FT-3D(S), FT-7, FT-8, FT-10, P3, PLC-2, PLC-3, PLC-4, PLC-5, PA3, PA1, 3PA1, 6PA1, 3FTS, 6FTS, 3FTCS, 6FTCS, 3FTINS, 6FTINS, 11FTINS, 3FTINS/3, 6FTINS/3, 11FTINS/3, 11LL, 11LL/3, 3PA1(S) Conforming to IS 14494:2019.

## BUS CABLE

Annealed tinned copper conductor, XLPE insulated, Cores / Pairs, Aluminium / Mylar or Copper / Mylar tape + drain wire individual / overall shielded, inner sheathed as required, Unarmoured / Armoured, PVC / CPE / LSZH sheathed Bus cables (Profibus / Fieldbus) conforming to FF-844 Standard.



## SINGLE CORE INDUSTRIAL FLEXIBLE CABLES

Energy Efficient Wires Range 0.50 sq.mm to 630 sq.mm in Class 5 copper conductors with excellent Flame Retardant Insulation properties.

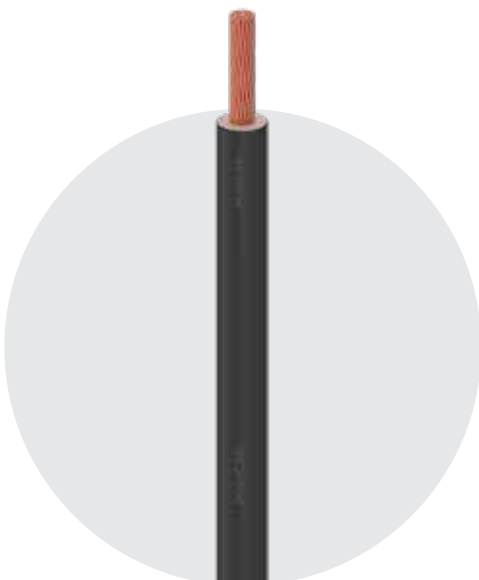

## CABLES FOR NUCLEAR POWER PLANT

Annealed Bare / Tinned, Solid / Stranded, Copper conductor, mica taped / XLPE / EPR / ETFE insulated, cores / pairs / triples assembled, Al. Mylar tape + Drain wire Individual / Overall shielded / unshielded, taped / Inner sheathed, G.I. / Aluminium Armoured / unarmoured and PVC / Low Smoke Low Halogen / CSP outer sheathed Radiation resistant Power, Control, Instrumentation, fire survival, unarmoured / armoured cables, conforming to NPCIL latest Specs No. PC-E-180, PC-E-184, PC-E-180, PC-E-234, PC-E-235, PC-E-236, PC-E-238, PC-E-240, PC-E-093. (Catenary cables as per PC-E-094; Thermocouple cable as per PC-E-237 are also available on demand).

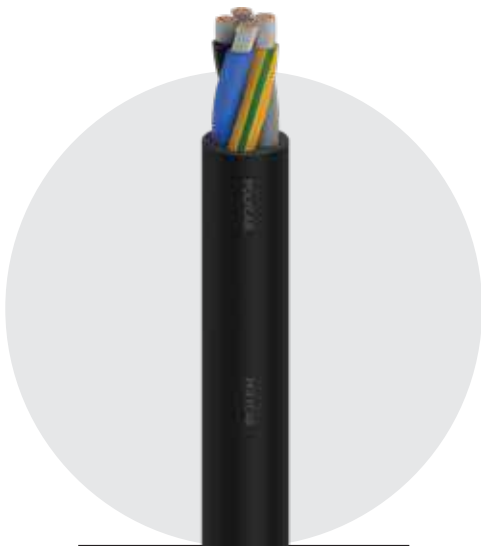
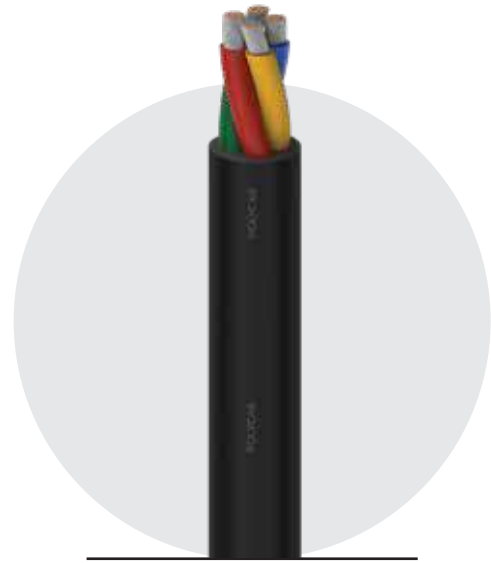

## MACHINE AND TOOLS CABLE

Annealed bunched copper conductor, PVC / HFFR insulated, laid up as required, unsheathed / sheathed with FR, FR-LSH, LSZH cables conforming to IS 694, IS 17048.

## DEFENCE CABLE

Annealed Bare / Tinned Copper conductor, LFH/Electron Beam cross-linked (EBXL) Polyolefin Halogen free insulated, twisted cores / pairs / triads, Annealed Tinned Copper (ATC) individual / collective screened, LFH / EBXL LSZH sheathed, overall ATC braided cables conforming to Def Stan 05-526, Def Stan 02-512 Part 3, Def Stan 02-525 and EED 50-12.

Annealed Bare / Tinned Copper conductor, Silicone Rubber/ Cross-linked Silicone Rubber insulated, Glass Braided / Lacquer coated, twisted cores / pairs / triads, Annealed Tinned Copper (ATC) individual/collective screened, LFH / EBXL LSZH sheathed, overall ATC braided fire survival cables conforming to Def Stan 05-527, Def Stan 02-512 Part 2 and EED 50-13.



## OIL & GAS CABLES OFFSHORE & ONSHORE

Single Core / Multicore, flexible copper conductor, conductor screened/unscreened, XLPO / HD XLPO type P, insulation screened / unscreened, EPR insulated, cores/ pairs / triples assembled, unshielded / metallic shielded, unarmoured / metallic braid armoured, Mud & Oil resistant XL-CPE / CSPE sheathed cables, temperature class 125°C, voltage grade 600V, 2kV / 1000V conforming to IEEE 1580:2010 (VFD cables and custom designed cables also available as per IEEE 1580).



## SUBMERSIBLE PUMP CABLES FOR OIL & GAS

Multicore Solid / Stranded copper conductor, Polypropylene / EPDM insulation, laid up cores, PE / HDPE / NBR sheathed, G.I. Armoured/unarmoured cables of different temperature classes 80°C to 180°C.

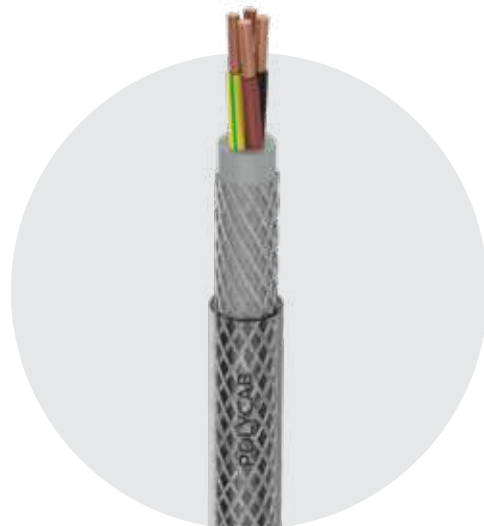

## INDUSTRIAL BRAIDED CABLE

Annealed bare bunched copper conductor, PVC insulated, PVC inner sheathed, Tinned copper wire braiding / G.I wire braided, PVC transparent / PVC sheathed conforming to IEC 60227-7:1995+A1:2003, IS 694:2010.



## LT AERIAL BUNCHED CABLES (ABC)

XLPE / Black HDPE insulated aluminium conductors laid together (twisted) around Aluminium Alloy / ACSR conductor, insulated or bare messenger wire to form the Aerial Bunched Cable. Optional features with neutral & street lighting conductor.

## BMS CABLE

Multicore Flexible Copper conductor, PVC insulated, Overall Aluminium Mylar tape shielded along with ATC Drain Wire / ATC Braided, PVC Outer Sheathed cables generally conforming to BS EN 50288-7.

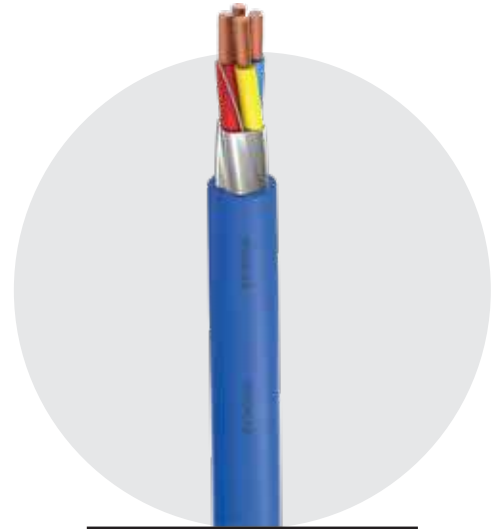

# BUILDING WIRES

## PANEL WIRE

Plain annealed bunched copper conductor, PVC insulated, unsheathed cable confirming to BS 6231, IS 694:2010, IS 17048.

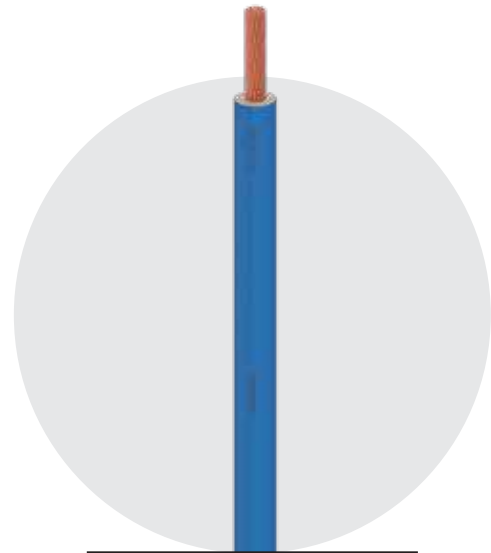
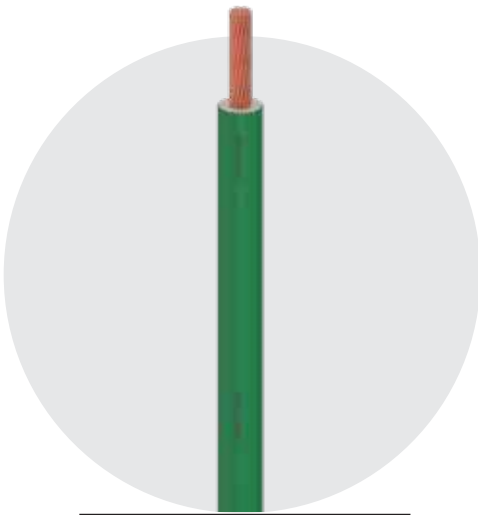

## HFFR-04XZ-K HALOGEN FREE FLAME RETARDANT

Single Core Multi-Stranded Copper conductor, HFFR cross-linked Insulated Wires with high current and excellent Flame Retardant Low Smoke properties having RoHS compliance supporting Green revolution.

## HFFR-01Z-K/03XZ-K HALOGEN FREE FLAME RETARDANT

Single Core Multi-Stranded Copper conductor, HFFR thermoplastic or HFFR cross-linked compound insulated wires with excellent Flame Retardant Low Smoke properties having RoHS compliance.

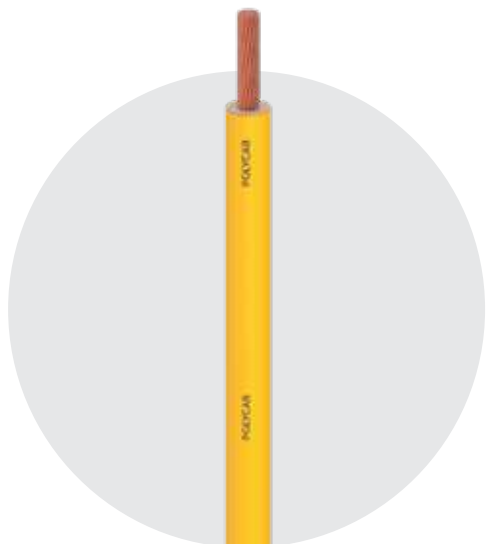

## HRFR-HEAT RESISTANT FLAME RETARDANT

Single Core Multi-Stranded Copper conductor, HRFR PVC Insulated Wires with Heat Resistant and excellent Flame Retardant properties.

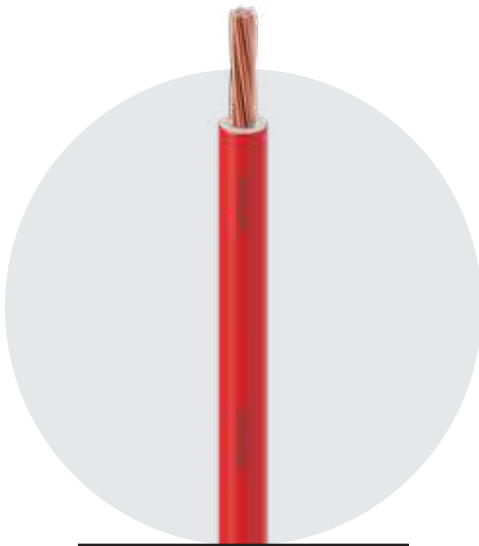
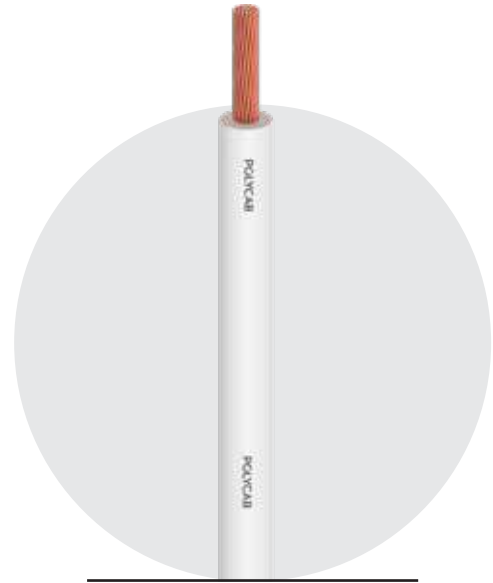

## FRLSH-FLAME RETARDANT LOW SMOKE & HALOGEN

Single Core Multi-Stranded Copper conductor, FRLS PVC Insulated Wires with excellent Flame Retardant and Low smoke properties.

## FR-FLAME RETARDANT

Single Core Multi-Stranded Copper conductor, FR PVC Insulated Wires with excellent Flame Retardant properties.

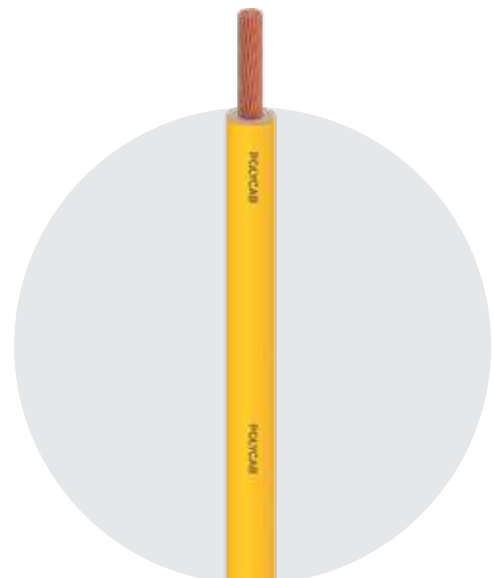

## HR-FRLS

Single Core Multi-Stranded Copper conductor, HR-FRLS PVC Insulated Wires with Heat Resistant, excellent Flame Retardant and Low Smoke properties.

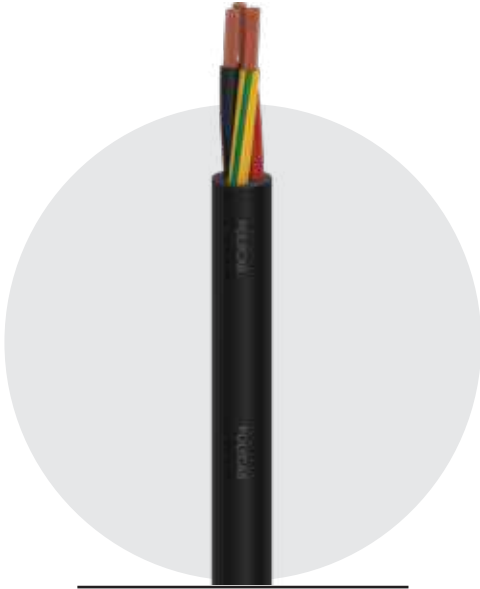
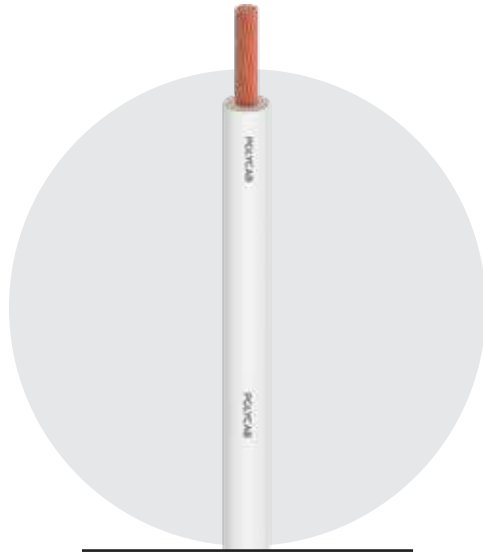

## MULTI CORE INDUSTRIAL FLEXIBLE CABLES

2 Core to 61 Core x 0.50 sq.mm to 4 sq.mm, 2 Core to 4 Core from 6 sq.mm to 120 sq.mm in Class 5 copper conductors with different Insulation and sheathing properties.



## SERVICE WIRE

Solid Aluminium conductor, PVC insulated, PVC sheathed twin flat cable conforming to IS 694:2010.

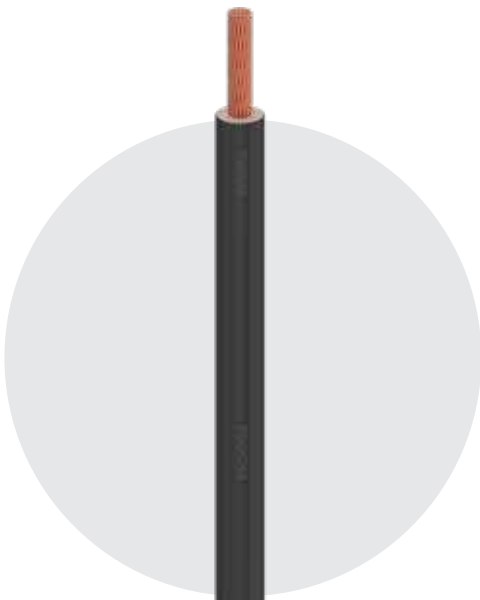

## MEDICAL WIRE

Annealed Bare Copper Conductor Bunch, Cross-linked HFFR compound insulated, unsheathed, Fungus free electrical wire conforming to IS 17048.

**POLYCAB GREEN WIRE  
HR-FR-LSH-LF**

## India's 1st Green Pro certified House Wires



### PRODUCT FEATURES

- Flame retardant
- Heat resistant
- Low smoke generation
- Low halogen content
- Non-toxic & lead free
- Superior grade raw materials
- RoHS compliant
- REACH compliant
- Higher water resistance
- Higher chemical resistance
- Higher insulation resistance
- High voltage breakdown resistance

### TECHNICAL SPECIFICATION

- Flammability: IEC 60332 - 1/IS 10810-52
- Minimum Bending Radius: 8D
- Nominal Voltage (U0/U): 650/1100 V
- Max. Operating Temperature: 85°C
- Temperature Range: -15°C to + 85°C
- Oxygen & temperature index: ASTM 2863/IS 10810-58
- Smoke density : IS 13360-6
- Low halogen: IS 10810-59

# DOWELLS

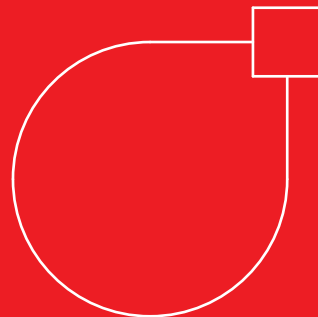
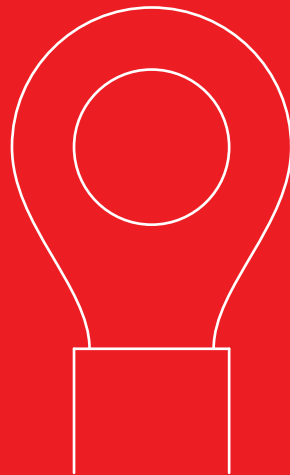



Market leaders in  
**CABLE ACCESSORIES**

## TUBE TERMINALS – MEDIUM DUTY

- Available in different sizes from 2.5 sq. mm. to 1000 sq.m.
- Oxygen free high conductivity Copper
- Electrolytic Aluminium IS 5082 grade
- Type tested as per BS - 4579/IEC - 61238
- The terminals can be made available in tin plating



## IN-LINE CONNECTORS

- Available in different sizes from 2.5 sq. mm. to 1000 sq. mm. in Aluminium
- In Copper Connectors, the size varies from 1.5 sq. mm. to 1000 sq. mm.
- Material: EC grade copper IS -191
- Electrolytic Aluminium IS- 5082 grade
- Available in natural finish and in electro-tinned finish



## TUBE TERMINALS – MEDIUM DUTY

- Available in different sizes from 2.5 sq. mm. to 1000 sq.m.
- Oxygen free high conductivity Copper
- Electrolytic Aluminium IS 5082 grade
- Type tested as per BS - 4579/IEC - 61238
- The terminals can be made available in tin plating

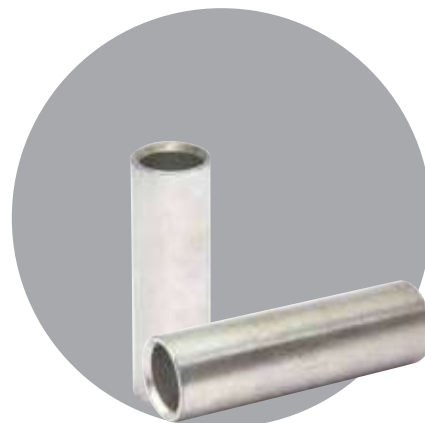

## COPPER TERMINALS

- Fork terminal
- Ring terminal
- Pin terminal
- Available in Non-insulated, Insulated and Pre-insulated
- EC grade copper IS - 191
- Electro-tinned finish

### SIZES:

Ring type (Range: 1 sq. mm. to 150 sq. mm.)

Pin type (Range: 1 sq. mm. to 95 sq. mm.)

Fork type (Range: 1 sq. mm. to 6 sq. mm.)



## BIMETALLIC LUGS & CONNECTORS

- Copper and aluminium friction welded
- Useful where the aluminium cable is terminated by copper bus bar
- Type tested IEC-61238
- ETP grade copper IS -191
- Electrolytic Aluminium IS – 5082

### SIZES:

Standard range available from 25 sq. mm. to 630 sq. mm.

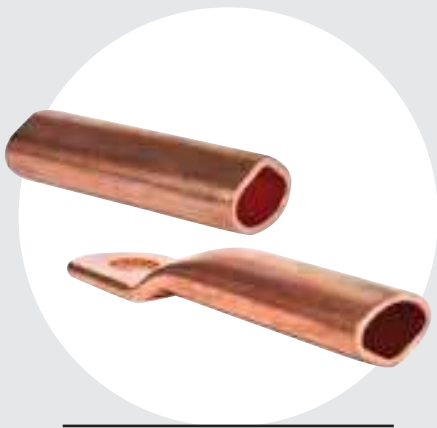

## SECTOR SHAPE LUGS & CONNECTORS

- Lugs with compact sector profile
- Easily fit into sector type cable
- Available for 2, 3, 3.5, 4 core cables
- No pinholes in the cross-sectional area
- ETP grade copper as per IS -191
- Electrolytic aluminium IS - 5082

### SIZES:

Standard range available from 25 sq. mm. to 400 sq. mm.

## ALUMINIUM FERRULES

- Suitable for Aluminium XLPE Conductors
- Available in different sizes from 25 sq. mm. to 1000 sq. mm.
- Electrolytic Aluminium IS-5082
- Natural finish



## ALUMINIUM CORROSION INHIBITING COMPOUND



- Recommended for application over the prepared end of the conductor and inside the ferrule
- GTZ - 8785
- Good sealing properties against moisture
- High temperature drop point
- Non-corrosive to aluminium copper, steel, tin & zinc

## SINGLE AND DOUBLE COMPRESSION GLANDS

- Made from Brass material
- Available in two varieties - Weather Proof & Flame Proof
- Suitable for armoured & unarmoured Cable
- Ingress protection IP - 67/BS- 6121/IEC-60079-0-2004
- Also available in Aluminium, SS & Polyamide

### SIZES:

Range for cable overall diameter varies from 6 mm. to 104 mm.

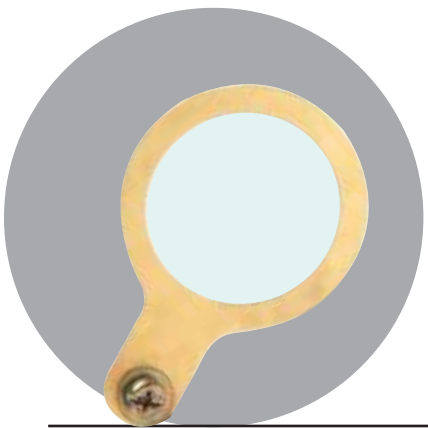

## EARTH TAG

- Made from Brass and Aluminium
- Is used for connecting or as an earth bond around the cable gland
- Available in various shapes & sizes
- Ensures earth continuity between the electrical equipment & the gland
- Can be coated or plated as per customer specification

## SHROUDS

- Black Polyvinyl Chloride high grade, also available in LSF & LSZH
- Provides additional protection and enhances IP rating of the gland termination
- Effective solution to weather and corrosion protection of cable gland
- Available in same gland size



## SMART CRIMPING TOOLS

- Non-insulated termination with interlocking arrangement & releasing system with capacity of 1.5 sq. mm. to 4.6 sq. mm.
- Hand operated hydraulic tools for 10 sq. mm. to 1000 sq. mm. cable
- W-type / D-type / P-type / T-type / H / RH- type dies also available
- Mechanical crimping tools for cable size 0.5 sq. mm. to 400 sq. mm. are also available



# CABLE TRAYS

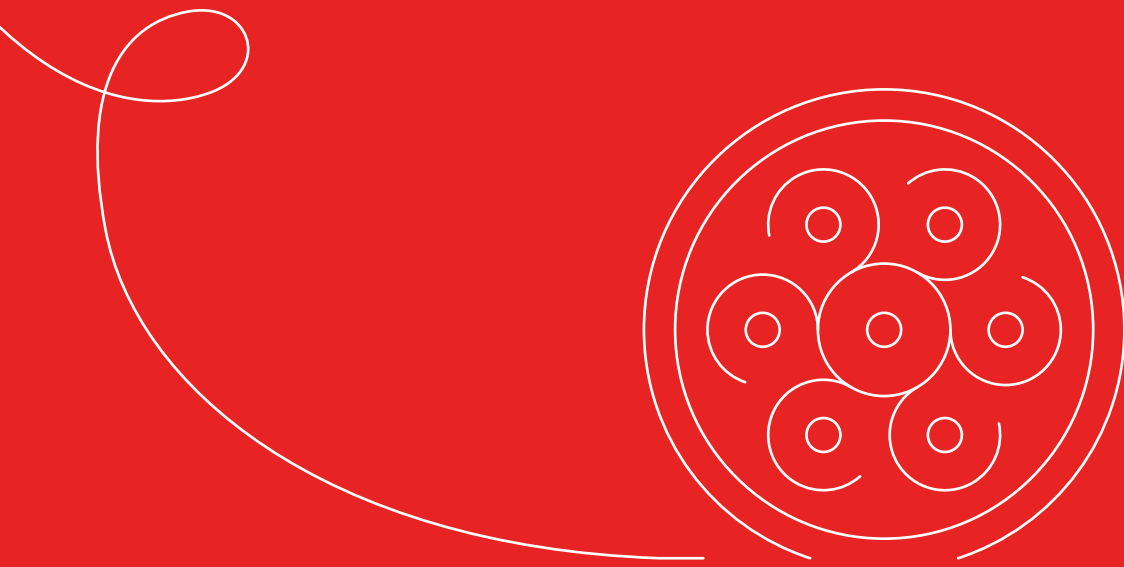

**ORGANIZE  
YOUR CABLES  
OPTIMIZE  
YOUR SPACE**



## PERFORATED CABLE TRAYS

WIDTH (mm)	HEIGHT (mm)	THICKNESS (mm)	FINISHING
50	25, 50	1.2, 1.5, 1.6, 2, 2.5, 3	"PRE GI (GI) HOT DIP (HDGI) POWDER COATED (PC)"
75			
100	25, 50, 75, 100, 125		
150			
250			
300			
450	50, 75, 100, 125	1.5, 1.6, 2, 2.5, 3	
500			
600		2, 2.5, 3	
750			
1000			



### FEATURES

- Good air ventilation through holes to prevent cable damage due to excess heat
- Easy drainage of the liquids through holes
- Better cable organising & it's protection
- Allow cable laying with flexibility & easy maintenance
- Best applications in data centres, infrastructure buildings, factories & plants

## PERFORATED TRAY ACCESSORIES

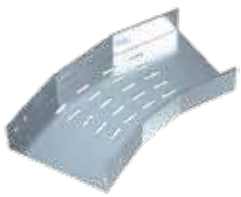

Available In  
30 D, 45 D, 60 D, 90 D



Vertical Inner  
Available In  
30 D, 45 D, 60 D, 90 D



Vertical Outer  
Available In  
30 D, 45 D, 60 D, 90 D



Reducer Bend

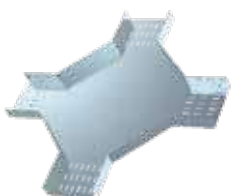

Square Bend



T Bend

LADDER CABLE TRAYS

WIDTH (mm)	HEIGHT (mm)	THICKNESS (mm)	
100	50, 75, 100	1.2, 1.5, 1.6, 2, 2.5, 3	"PRE GI (GI) HOT DIP (HDGI) POWDER COATED (PC)
150			
250			
300	50, 75, 100, 125	1.5, 1.6, 2, 2.5, 3	
400			
450			
500			
600	2, 2.5, 3		
750			
1000			
1200			



FEATURES

- Design with side rails & horizontal rungs at specific intervals to create a structure like ladder as it's name
- Open design for excellent air ventilation for bunch of cables
- High load bearing capacity for heavy duty cables
- Most efficient use for the armoured cables
- Best applications in power distribution systems, oil & refineries, factories & process plants

LADDER TRAY ACCESSORIES



Available In  
30 D, 45 D, 60 D, 90 D



Vertical Inner  
Available In  
30 D, 45 D, 60 D, 90 D



Vertical Outer  
Available In  
30 D, 45 D, 60 D, 90 D



Reducer Bend

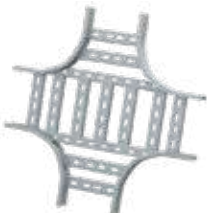

Square Bend



T Bend

**RACEWAY CABLE TRAYS**

WIDTH (mm)	HEIGHT (mm)	THICKNESS (mm)	FINISHING
50	25, 50	1.2, 1.5, 1.6, 2, 2.5, 3	"PRE GI (GI) HOT DIP (HDGI) POWDER COATED (PC)"
75			
100			
150	25, 50, 75, 100, 125		
250			
300			
450			
500	50, 75, 100, 125	1.5, 1.6, 2, 2.5, 3	
600		2, 2.5, 3	
750			
1000			



**FEATURES**

- Provide secure pathway of the cables with solid surface
- Protection of the cables from the mechanical damage
- Best application for the concealed & under floor cable laying
- Served with junction boxes & covers
- Single, double & three compartment options are available
- Best applications in commercial buildings, hospitals, corporate offices, server rooms & data centres, health care & pharma plants, food process plants"

**RACEWAY TRAY ACCESSORIES**



Available In  
30 D, 45 D, 60 D, 90 D



Vertical Inner  
Available In  
30 D, 45 D, 60 D, 90 D



Vertical Outer  
Available In  
30 D, 45 D, 60 D, 90 D



Reducer Bend



Square Bend



T Bend

**CABLE TRAY COVERS**

WIDTH (mm)	HEIGHT (mm)	THICKNESS (mm)	FINISHING
50	10, 15, 25	1.2, 1.5, 1.6, 2, 2.5, 3	"PRE GI (GI) HOT DIP (HDGI) POWDER COATED (PC)"
75			
100			
150			
250			
300			
400			
450			
500			
600			
750			
1200		1.6, 2, 2.5, 3	



**FEATURES**

- Best Use To Protect Cables
- To Prevent Mechanical Damages During Under Floor Wiring
- Phase Distribution Or Separation Between Electrical & Elv Cables Using Compartment Options
- Mostly Used With Raceway Cable Trays

**CABLE TRAY SUPPORTS**



# CONDUITS

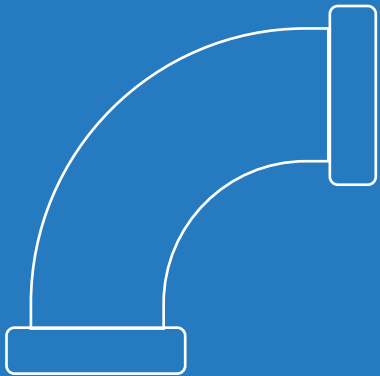
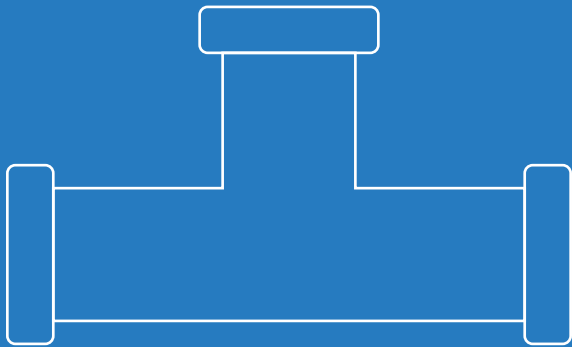



## POLYCAB CONDUITS SPECIFICATION

Polycab is an ISO 9001:2015 certified organization. Polycab conduits & fittings are manufactured in accordance with Indian standards viz. IS:9537 P3 and IS:3419 respectively.

### COLOUR

Polycab conduits and fittings are available in three different colors.



### DIMENSIONS OF uPVC CONDUIT IS : 9537 PART 3

NOMINAL SIZE MM	OUTSIDE DIAMETER MM	TOLERANCE ON OUTSIDE DIAMETER MM	INSIDE DIAMETER (MIN) MM		
			LIGHT	MEDIUM	HEAVY
20	20	- 0.3	17.4	16.9	15.8
25	25	- 0.4	22.1	21.4	20.6
32	32	- 0.4	28.6	27.8	26.6
40	40	- 0.4	35.8	35.4	34.4
50	50	- 0.5	45.1	44.3	43.2

A faithful companion to Polycab wires are the Polycab uPVC conduits and pipes. Made only from the highest grade of waterproof and fire-resistant polymers these are absolutely essential for protecting electrical wire and ensuring greater safety to every electrical circuit.

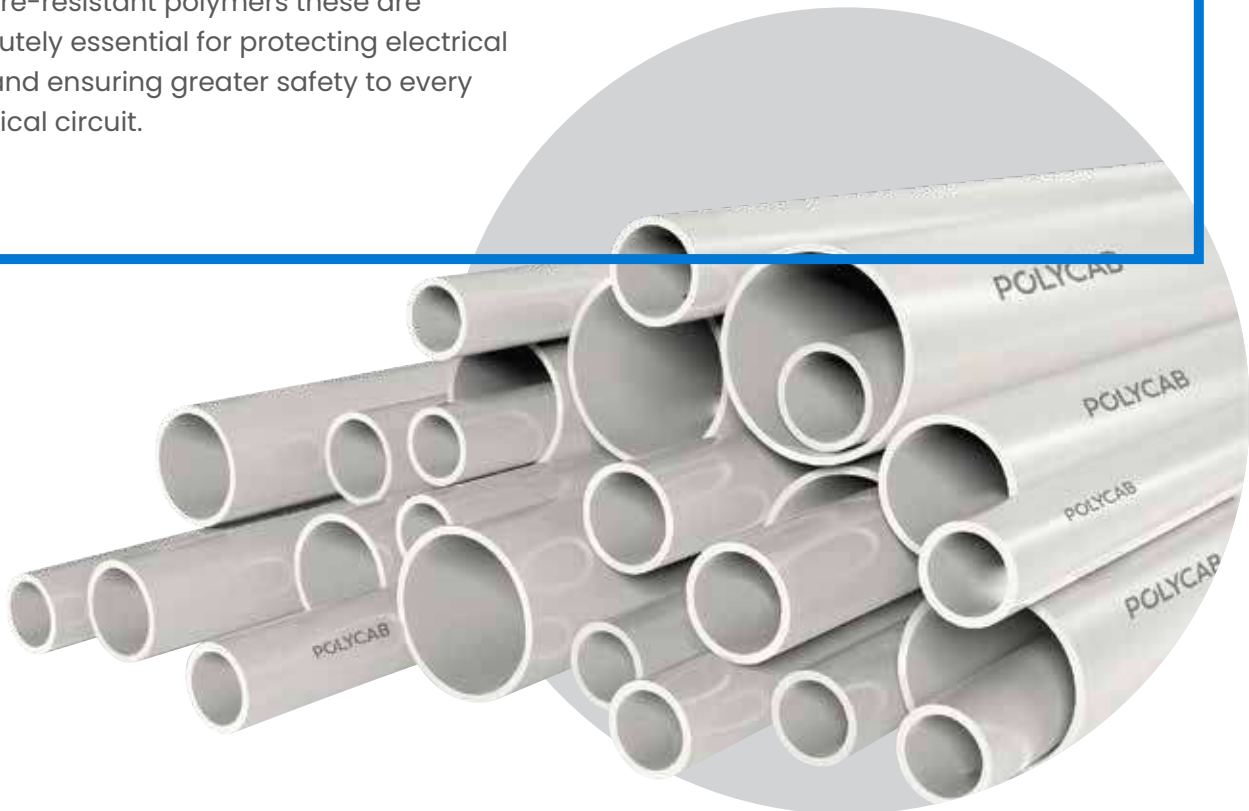

## MMS (MEDIUM MECHANICAL STRESS) FRLS

Product Code	Size OD(mm)	Standard Pack
CPI0220001	20	75 X 3m
CPI0225001	25	50 X 3m
CPI0232001	32	25 X 3m
CPI0240001	40	25 X 3m
CPI0250001	50	15 X 3m

## HMS (HEAVY MECHANICAL STRESS) FRLS

Product Code	Size OD(mm)	Standard Pack
CPI0320001	20	75 X 3m
CPI0325001	25	50 X 3m
CPI0332001	32	25 X 3m
CPI0340001	40	25 X 3m
CPI0350001	50	15 X 3m

## LHSFT MMS

Product Code	Size OD(mm)	Standard Pack
CPI0420002	20	75 X 3m
CPI0425002	25	50 X 3m
CPI0432002	32	25 X 3m
CPI0440002	40	25 X 3m
CPI0450002	50	15 X 3m

## LHSFT HMS

Product Code	Size OD(mm)	Standard Pack
CPI0720002	20	75 X 3m
CPI0725002	25	50 X 3m
CPI0732002	32	25 X 3m
CPI0740002	40	25 X 3m
CPI0750002	50	15 X 3m

## LMS (LIGHT MECHANICAL STRESS) FRLS

Product Code	Size OD(mm)	Standard Pack
CPI0120001	20	75 X 3m
CPI0125001	25	50 X 3m
CPI0132001	32	25 X 3m
CPI0140001	40	25 X 3m
CPI0150001	50	15 X 3m

## uPVC CONDUITS AND FITTINGS

### CIRCULAR BOX - TERMINAL (1WAY)

Product Code	Size OD(mm)	Standard Pack	Transportation Pack	
CFT0120001	20	50	700	
CFT0125001	25	40	560	

### CIRCULAR BOX - ANGLE (2WAY)

Product Code	Size OD(mm)	Standard Pack	Transportation Pack	
CFT0220001	20	40	640	
CFT0225001	25	32	448	

### CIRCULAR BOX - THROUGH (2WAY)

Product Code	Size OD(mm)	Standard Pack	Transportation Pack	
CFT0320001	20	40	640	
CFT0325001	25	32	448	

### CIRCULAR BOX - TEE (3WAY)

Product Code	Size OD(mm)	Standard Pack	Transportation Pack	
CFT0420001	20	36	432	
CFT0425001	25	28	336	

### CIRCULAR BOX - INTERSECTION (4WAY)

Product Code	Size OD(mm)	Standard Pack	Transportation Pack	
CFT0520001	20	36	432	
CFT0525001	25	21	336	

### CIRCULAR BOX - 'U' TYPE (2WAY)

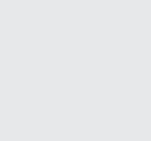
Product Code	Size OD(mm)	Standard Pack	Transportation Pack	
CFT2420001	20	20	360	
CFT2425001	25	20	360	

### CIRCULAR BOX - 'Y' TYPE (3WAY)

Product Code	Size OD(mm)	Standard Pack	Transportation Pack	
CFT2520001	20	20	360	
CFT2525001	25	20	360	

## CIRCULAR BOX - 'H' TYPE (4WAY)

Product Code	Size OD(mm)	Standard Pack	Transportation Pack
CFT2620001	20	20	360
CFT2625001	25	20	360

## DEEP CIRCULAR BOX - TERMINAL (1WAY)

Product Code	Size OD(mm)	Standard Pack	Transportation Pack
CFT0620001	20	20	280
CFT0625001	25	20	280
CFT3432001	32	12	300



## DEEP CIRCULAR BOX - ANGLE (2WAY)

Product Code	Size OD(mm)	Standard Pack	Transportation Pack
CFT0720001	20	20	280
CFT0725001	25	20	280
CFT3132001	32	12	250



## DEEP CIRCULAR BOX - THROUGH (2WAY)

Product Code	Size OD(mm)	Standard Pack	Transportation Pack
CFT0820001	20	20	280
CFT0825001	25	20	280
CFT3232001	32	12	216



## DEEP CIRCULAR BOX - TEE (3WAY)

Product Code	Size OD(mm)	Standard Pack	Transportation Pack
CFT0920001	20	16	224
CFT0925001	25	16	224
CFT3532001	32	12	168



## DEEP CIRCULAR BOX - INTERSECTION (4WAY)

Product Code	Size OD(mm)	Standard Pack	Transportation Pack
CFT1020001	20	16	224
CFT1025001	25	15	210
CFT3632001	32	12	168



## CIRCULAR LID 65 WITH SCREWS

Product Code	Size OD(mm)	Standard Pack	Transportation Pack	
CFT2265001	Standard	150	1950	

## FAN BOX (STANDARD)

Product Code	Size OD(mm)	Standard Pack	Transportation Pack	
CFT1120001	20	12	168	
CFT1125001	25	12	168	

## FAN BOX (LARGE)

Product Code	Size OD(mm)	Standard Pack	Transportation Pack	
CFT1220004	20	8	120	
CFT1225004	25	8	120	

## FAN BOX WITH ROD

Product Code	Size OD(mm)	Standard Pack	Transportation Pack	
CFT3020001	20/25	91	91	

## SPACE BAR SADDLE

Product Code	Size OD(mm)	Standard Pack	Transportation Pack	
CFT1520001	20	150	2550	
CFT1525001	25	150	2550	

## SADDLE STRAP

Product Code	Size OD(mm)	Standard Pack	Transportation Pack	
CFT2320001	20	300	5400	
CFT2325001	25	250	4500	

## COUPLER

Product Code	Size OD(mm)	Standard Pack	Transportation Pack	
CFT1319001	19	48	480	
CFT1320001	20	50	2500	
CFT1325001	25	50	1600	
CFT1332001	32	24	240	
CFT1340001	40	14	252	
CFT1350001	50	09	180	

## REDUCERS COUPLER (PIPE TO PIPE)

Product Code	Size OD(mm)	Standard Pack	Transportation Pack	
CFT31202501	25>20	70	1400	
CFT31253201	32>20	70	840	
CFT31253201	32>25	70	840	

## SLIP TYPE BEND NORMAL

Product Code	Size OD(mm)	Standard Pack	Transportation Pack	
CFT1420001	19	48	864	
CFT1425001	20	48	864	
CFT1425001	25	30	600	

## SLIP TYPE BEND LONG

Product Code	Size OD(mm)	Standard Pack	Transportation Pack	
CFT2719001	19	48	864	
CFT2720001	20	48	864	
CFT2725001	25	24	432	
CFT1432001	32	16	288	
CFT1110001	40	8	160	
CFT1450001	50	5	75	

## INSPECTION BEND

Product Code	Size OD(mm)	Standard Pack	Transportation Pack	
CFT2120001	20	35	630	
CFT2125001	25	25	375	

## ROUND TEE

Product Code	Size OD(mm)	Standard Pack	Transportation Pack	
CFT1820001	20	100	1300	
CFT1825001	25	60	780	

## INSPECTION TEE

Product Code	Size OD(mm)	Standard Pack	Transportation Pack	
CFT2020001	20	35	700	
CFT2025001	25	24	432	

## ROUND ELBOW

Product Code	Size OD(mm)	Standard Pack	Transportation Pack	
CFT1720001	20	150	1800	
CFT1725001	25	100	1300	

## INSPECTION ELBOW

Product Code	Size OD(mm)	Standard Pack	Transportation Pack	
CFT1920001	20	60	1080	
CFT1925001	25	36	540	

## NON ISI PP CIRCULAR BOX - TERMINAL (1WAY)

Product Code	Size OD(mm)	Standard Pack	Transportation Pack	
CFT3220001	20	50	700	
CFT3225001	25	40	560	

## NON ISI PP CIRCULAR BOX - ANGLE (2WAY)

Product Code	Size OD(mm)	Standard Pack	Transportation Pack	
CFT3320001	20	40	640	
CFT3325001	25	32	448	

## NON ISI PP CIRCULAR BOX - THROUGH (2WAY)

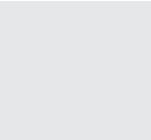
Product Code	Size OD(mm)	Standard Pack	Transportation Pack	
CFT3420001	20	40	640	
CFT3425001	25	32	448	

## NON ISI PP CIRCULAR BOX - TEE (3WAY)

Product Code	Size OD(mm)	Standard Pack	Transportation Pack	
CFT3520001	20	36	432	
CFT3525001	25	28	336	

## NON ISI PP CIRCULAR BOX - INETERSECTION (4WAY)

Product Code	Size OD(mm)	Standard Pack	Transportation Pack	
CFT3620001	20	36	432	
CFT3625001	25	21	336	

## NON ISI PP CIRCULAR BOX - INETERSECTION (4WAY)

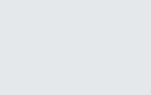
Product Code	Size OD(mm)	Standard Pack	Transportation Pack	
CFT3865001	20/25	150	1950	

## CONCEALED METAL & PLASTIC SURFACE BOXES

AVAILABLE IN : 1, 1.2, 1.4 and 1.6

DEPTH : 40mm & 50mm

### FEATURES

- Complete range available with standard sizes
- Edge to Edge fitment with our modular plates
- Metal concealed boxes are made from G.I sheet with premium Matt Finish
- Standard Gauge or thickness of 0.9mm for lower modules and 1mm for higher modules
- Locking structure to provide strength and no rusting as there is no spot welding used
- Smooth floating clamp for ease of installation
- Earthing provision for Electrical Safety
- Single punch, knock out for ease of installation



# SWITCHES





SWITCHES  
DESIGNED FOR

# MODERN LIVING



# TAP INTO

## MODERN SIMPLICITY



Vertical &  
Horizontal  
Installation



Slim & Sleek  
Design



Aesthetic  
Design



# ETIRA

ETIRA switches encapsulate modern simplicity and minimalism, combining style and quality in a design tailored for the practical, modern consumer. They not only add a touch of modernity to your space with their clean aesthetics but also enhance the environment with an atmosphere of calm sophistication, celebrating the beauty of simplicity.

Black



White



Mag Gray

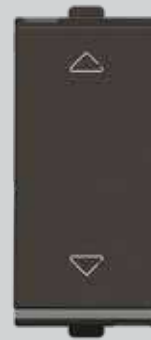

## SILVAZ COVER PLATE AND BASE PLATE

Plates with Silver Lining



## STYLAZ COVER PLATE AND BASE PLATE

Plates without Silver Lining

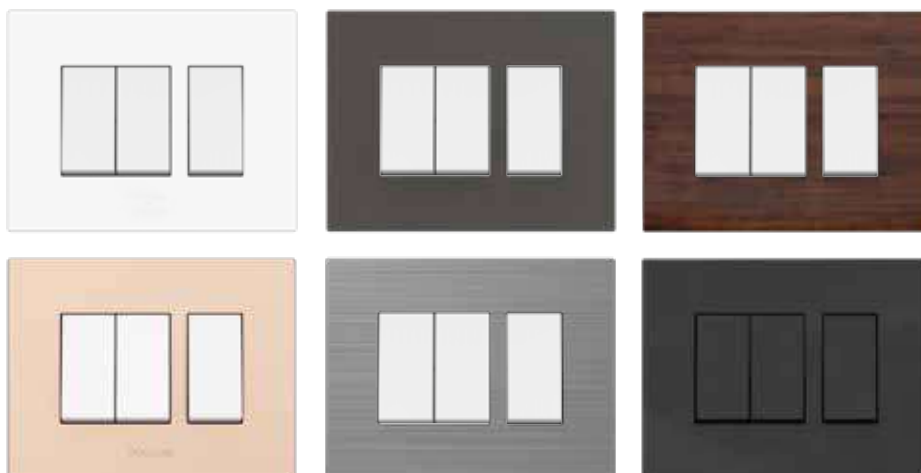

# ETIRA

# POLYCAB

## Vertical and Horizontal orientation

### Easy to Install

Polycab Etira switches can be oriented horizontally or vertically, and look equally good both ways!



## Product Specification

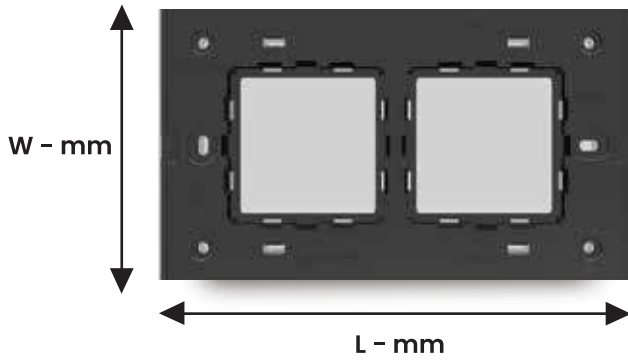

## PLATES

**1M**

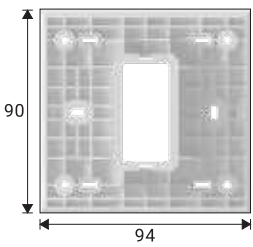

**2M**

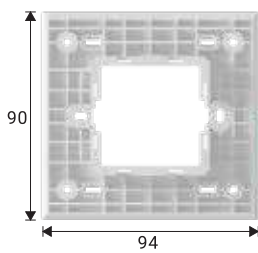

**3M**

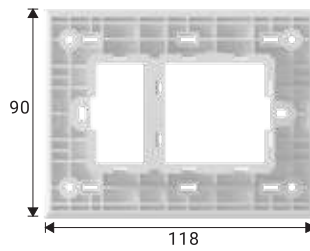

**4M**

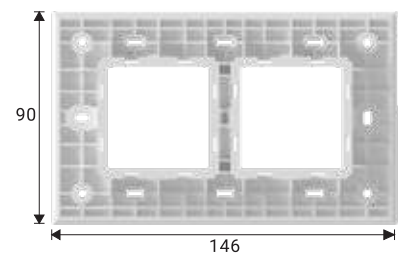

**6M**

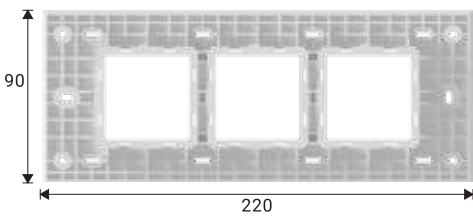

**8M Horizontal**

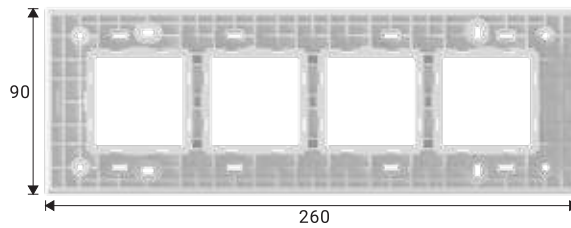

**8M Square**

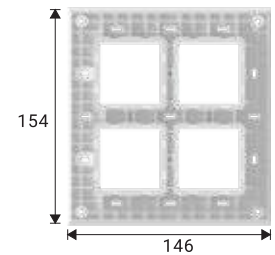

**12M**

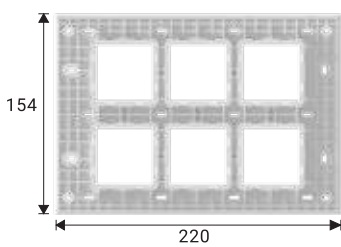

**16M Horizontal**

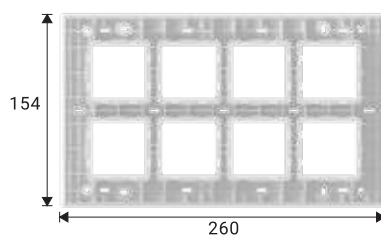

**18M Square**

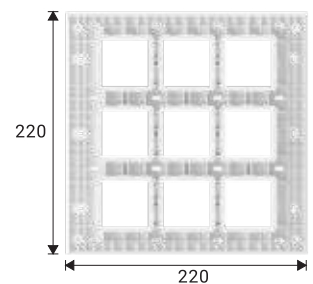

## SWITCHES 6AX



## BELL SWITCHES



## SWITCHES 16AX



## POWER SWITCHES

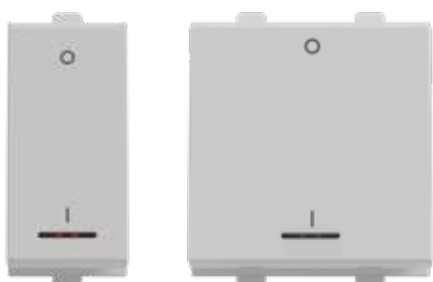

## SOCKETS



# ETIRA

## FAN REGULATOR & DIMMER

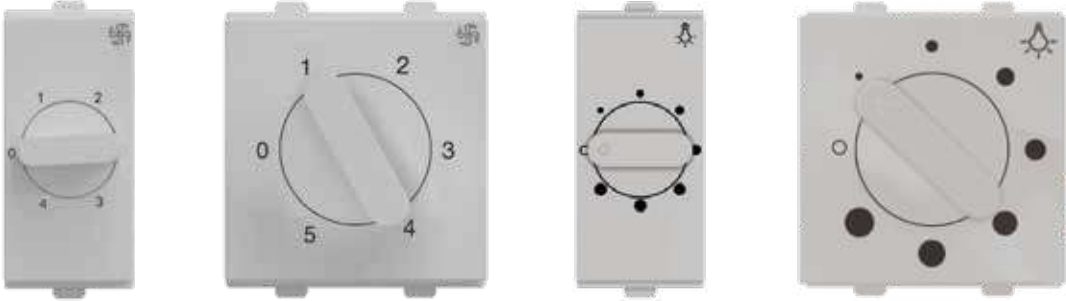

## SUPPORT MODULES



## HOSPITALITY RANGE



## MODULAR MCBS



# LUXURY

IN EVERY CLICK



5 Part  
Mechanism



UV Stabilised  
Polymers



Soft click  
Switch

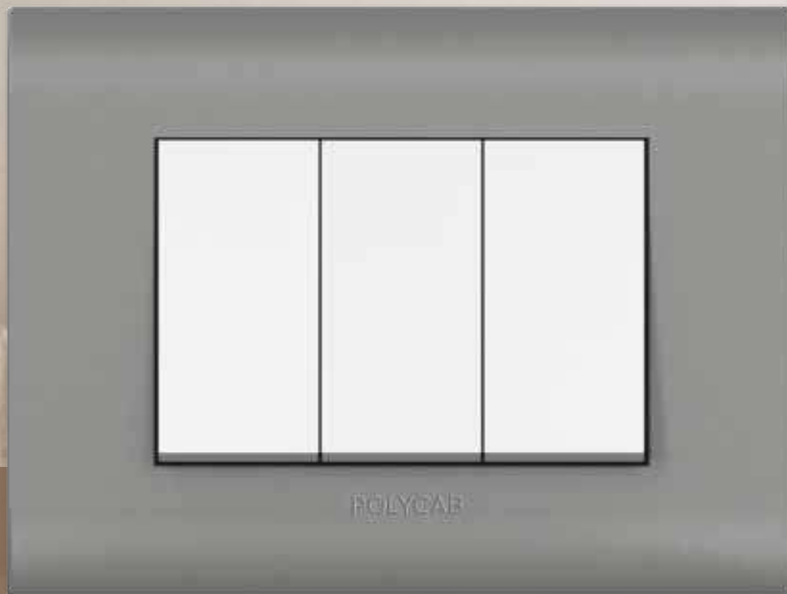

## LEVANA

LEVANA modular switches blend timeless elegance with advanced technology, offering both durability and sophisticated functionality. They not only enhance the luxury and class of your living space but also instill a sense of confidence and opulence, elevating your everyday experience.

# 5 PART MECHANISM

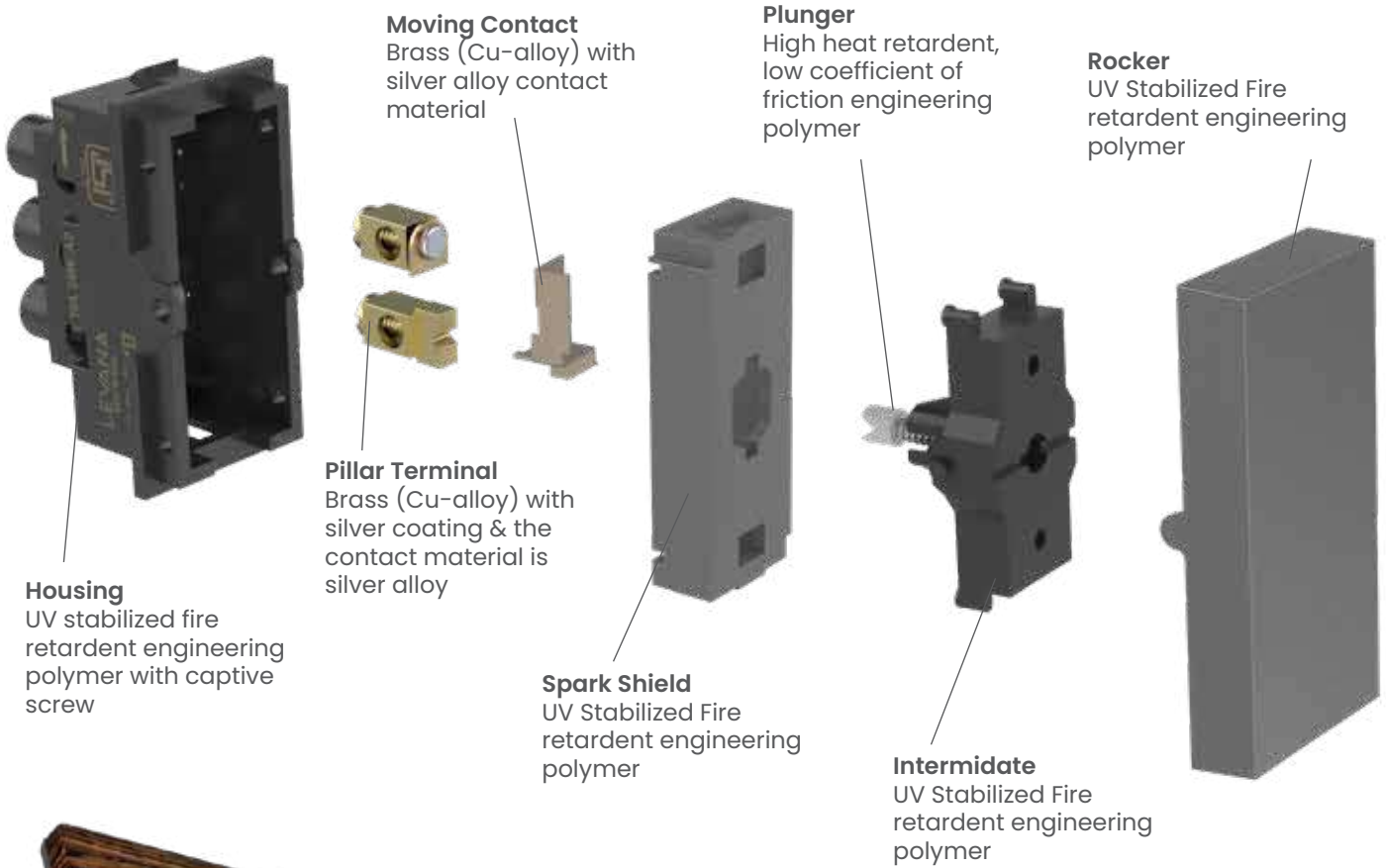

SOFT CLICK SWITCH

-  **Low Sound of Operation**
-  **Greater Durability**
-  **Higher Electrical Safety**
-  **Tested for 1 Lac Clicks**

**CAPRINA PLATE**

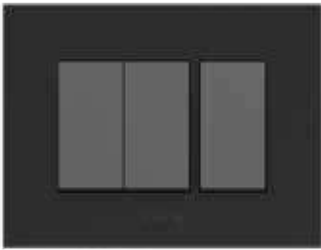

Black

**PRODUCT FEATURES:**

	Double rocker mechanism
	Soundless soft touch
	Flame retardant polycarbonate
	Bimetal contacts with silver tip

**ALSO AVAILABLE:**

- Magnesium Grey
- African Wenge
- Champagne Gold
- Natural Wood
- White
- Black

**VALENCIA COVER PLATES**

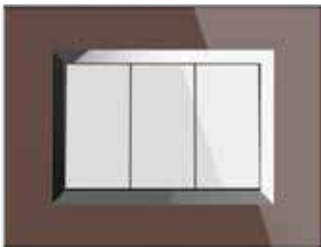

Chocolate

**PRODUCT FEATURES:**

	Double rocker mechanism
	Soundless soft touch
	Flame retardant polycarbonate
	Bimetal contacts with silver tip

**ALSO AVAILABLE:**

- Red
- White
- Bronze Mirror
- Frosted Mirror
- Chocolate
- Silver Frosted Mirror
- Black
- Silver

**CURL PLATE**

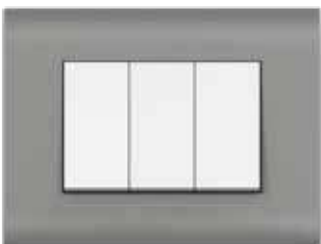

Magnesium Grey

**PRODUCT FEATURES:**

	Double rocker mechanism
	Soundless soft touch
	Flame retardant polycarbonate
	Bimetal contacts with silver tip

**ALSO AVAILABLE:**

- White

**CURL PLUS**



Wine Red

**PRODUCT FEATURES:**

	Double rocker mechanism
	Soundless soft touch
	Flame retardant polycarbonate
	Bimetal contacts with silver tip

**ALSO AVAILABLE:**

- Magnesium Grey
- Matt Black
- Sparkle Blue

SWITCHES

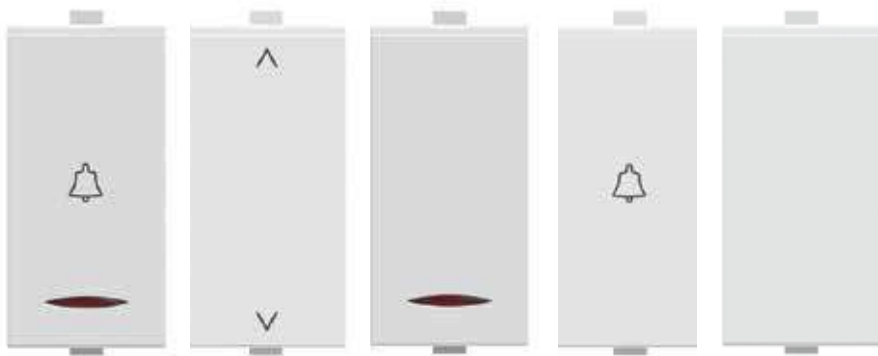

PRODUCT FEATURES:

- 5 part mechanism
- Soft touch control
- Minimum sound of operation

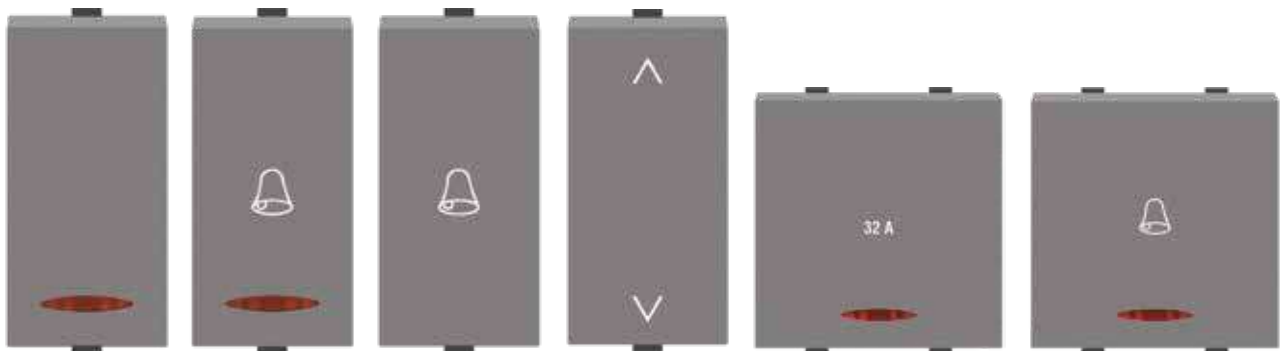

SOCKETS

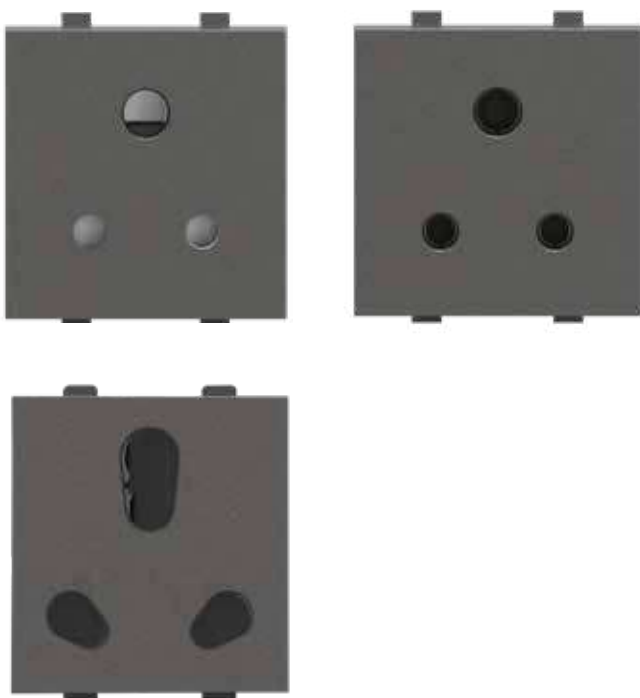

PRODUCT FEATURES:

- High flame retardant polymer
- Safety shutter
- Highly durable
- No socket burning
- Smooth shutter operation
- Additional spring action for durable grip
- No loose contact
- No sparking

**REGULATOR AND DIMMER**



**PRODUCT FEATURES:**

- Classic style
- Step regulator
- Distinct variation in speed
- 360° operation
- Capacitor based filter circuit
- Durable knob

**MOTOR STARTER**



**PRODUCT FEATURES:**

- Overload protection
- Longer electrical and mechanical life
- IP20 protection

**HOSPITALITY PRODUCTS**





# SWITCHGEARS

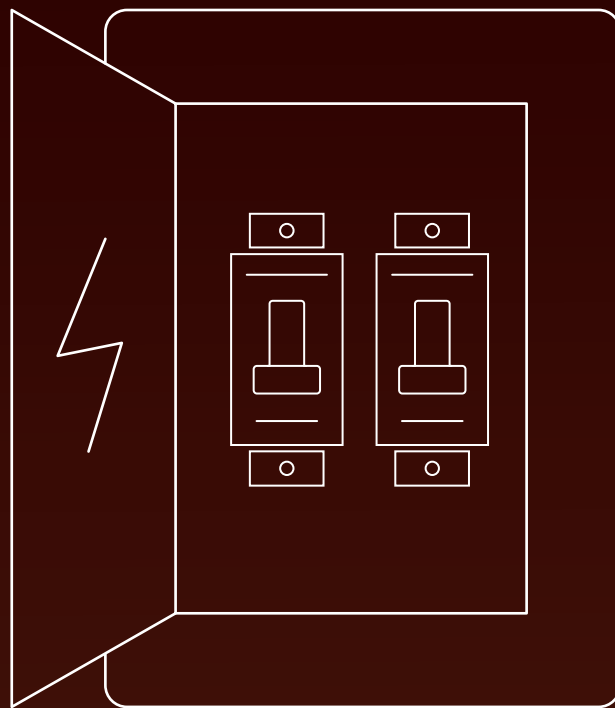

# ASSURANCE OF A SAFE LIFE



## MINIATURE CIRCUIT BREAKER (MCB)

(In accordance with IS / IEC 60898-1) 240V/ 415V AC,  
50Hz, 10kA Breaking Capacity

∅	SP / SPN / DP / TP / TPN / FP
—	Range – 0.5A – 63A
⌋	Curve Type – B / C / D
⚡	Breaking Capacity – 6kA & 10kA



### 10kA FEATURES

- Positive contact position indication
- Attractive label holder
- Large & dual terminal
- Bi-stable DIN clip position
- Air flow channel
- Ease of clamping
- Enhanced safety
- Energy limiting class 3
- Aesthetically designed with safety
- High quality contact tips
- Locking shutter
- 13 plates arc chamber
- Low power loss
- Line load reversibility
- Neutral pole protected

### 6kA FEATURES

- Air flow channel
- Ease of clamping
- enhanced safety
- Energy limiting class 3
- Aesthetically designed with safety
- High quality contact tips
- 13 plate arc chamber
- Low power loss
- line load reversibility

## MINIATURE CIRCUIT BREAKER DC (MCB)

(In accordance with IEC 60947-2) 250Vdc per pole,  
6kA Breaking Capacity



∅	SP / DP / FP
—	Range – 0.5A – 63A
⚡	Breaking Capacity – 6kA
⚡	250v DC per pole

### FEATURES

- Positive contact position indication
- Attractive label holder
- Large & dual terminal
- Bi-stable DIN clip position
- Air flow channel
- Ease of clamping
- Enhanced safety
- Aesthetically designed with safety
- High quality contact tips
- Locking shutter
- 13 plates arc chamber
- Low power loss
- Line load reversibility
- Line load reversibility in case of DP MCB

**ISOLATORS**

(In accordance with IS / IEC 60947-3) 240V/ 415V AC, 50Hz, AC - 22A

Ø	SP / DP / TP / FP
—	Range - 40A - 125A



**FEATURES**

- Positive contact position indication
- Attractive label holder
- Large & dual terminal
- Bi-stable DIN clip position
- Air flow channel
- Ease of clamping
- Enhanced safety
- Aesthetically designed with safety
- High quality contact tips
- Locking shutter
- Low power loss
- Line load reversibility

**MCB CHANGEOVER**

(In accordance with IS/IEC 60947-3)



Ø	DP / FP
—	Range - 25A - 63A

**Features**

- Compact design
- Fire retardant
- Reliable
- Easy to use
- Safe with IP 20 protection
- Ease of clamping
- Enhanced safety
- Highly durable

## RESIDUAL CURRENT CIRCUIT BREAKER (RCCB)

(In accordance with IS 12640-1, IEC 61008-1)

∅	SP / FP
—	Range – 25 / 40 / 63A
⌋	Sensitivity – 30 / 100 / 300mA
⚡	Withstand Capacity – 10kA

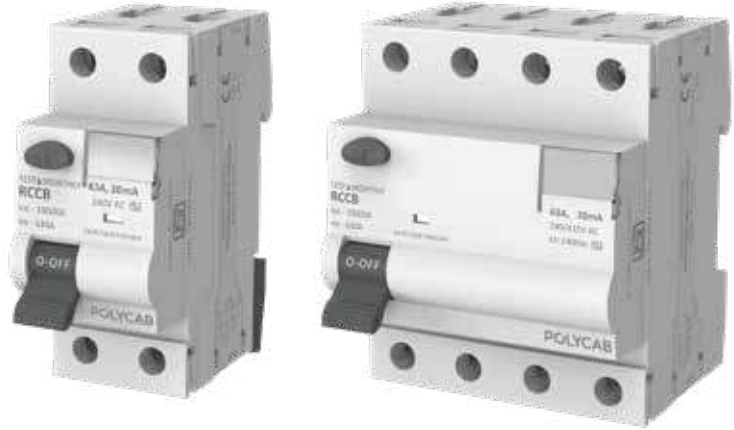

### FEATURES

- Test button
- Combi-head screw
- Advanced neutral
- Real trip indication
- Large and dual termination
- Label holder
- Safety terminal
- Easy DIN extraction
- Aesthetically designed with safety
- High quality contact tips
- Low power loss
- Neutral Marking
- Functionally independent of line voltage (Electromechanical RCCB)

## RESIDUAL CURRENT CIRCUIT BREAKER WITH OVER CURRENT PROTECTION (RCBO)

(In accordance with IS 12640-2, IEC 61009-1)



∅	DP / FP
—	Range – 6A – 63A
⌋	Sensitivity – 30 / 100 / 300mA
⚡	Breaking Capacity – 10kA

### FEATURES

- Mid-trip indication
- Contact position indicator
- Neutral marking
- Test button
- Easy DIN extraction
- Aesthetically designed with safety
- High quality contact tips
- Low power loss
- Functionally independent of line voltage (Electromechanical RCBO)

ACCL

Ø	Single Phase
⚙️	Mains Current Range - 30 A Genset Current Range - 0.5 A to 30 A



FEATURES

- Safe – IP 20 protection
- Technically superior – Unique contactor based technology
- FR material body
- Break before make changeover with higher air gap
- Convenient – Auto reset facility
- Reliable – Conditional short circuit capacity – 5KA
- Lower power consumption – Power consumed is less than 0.2 VA during main supply and 15VA during generator operation
- Long life – 25000 Electrical operations
- Heavy Duty – Utilisation category AC22A (IEC 60947-3) and AC32A (IEC 60947-6)
- Alert – Overload indication on Genset side by LED and Beep

MOULDED CASE CIRCUIT BREAKERS (MCCB)



FEATURES

- Moulded Case Circuit Breakers
- Complies to IS/IEC 60947-2 standards.
- Wide range 32-1250A in 3& 4 Pole.
- Fixed as well as Adjustable type.
- 10-85KA Short Circuit Breaking capacity
- ICu=100% ICs
- Rated insulation voltage 800 V AC
- Wide range of accessories Aux / Alarm Switch , Under Voltage, Shunt Trip and Rotary Handles
- Rated for use at 55° C temperature.

## DISTRIBUTION BOX

### FEATURES

- As per IS 1303 / 8623
- Aesthetically superior to suit the interior
- Suitable for flush and surface mounting
- Ready to use DB – provided with 100A phase bus-bar, neutral bar
- Cement spill protector
- Removable top and bottom gland plates with adequate knockouts for easy wiring
- DBs made up of CRCA sheet
- Detachable gland plate
- Door knob
- Door earthing
- Corner safety
- Earthing bolt



## TPN DISTRIBUTION BOARD

(In accordance with IS 13032, IS 8623, IEC / BSEN 61439-3)  
(RAL - 9003 fine white texture, IP 30 - Single Door DB)



### TP&N Distribution Board (Suitable for FP Incoming and SP Outgoing)

No. of Ways	I/C + O/G Ways	Item Code Single Door
4W	4 + 12	GPDTN10031
4W	8 + 12	GPDTN10032
6W	8 + 18	GPDTN10033
8W	8 + 24	GPDTN10034
12W	8 + 36	GPDTN10030

## SPN DISTRIBUTION BOARD

(RAL - 9003 fine white texture, IP 42 - Double Door DB)

### SPN Distribution Board (Suitable for DP Incoming and SP Outgoing)

No. of Ways	Item Code Double Door
4W	GPDSN20016
6W	GPDSN20012
8W	GPDSN20017
12W	GPDSN20018
16W	GPDSN20019



**TPN DISTRIBUTION BOARD**

(RAL - 9003 fine white texture, IP 42 - Double Door DB)



**TPN Distribution Board (Suitable for FP Incoming and SP Outgoing)**

No. of Ways	I/C + O/G Ways	Item Code Single Door
4W	4 + 12	GPDTN20064
4W	8 + 12	GPDTN20065
6W	8 + 18	GPDTN20066
8W	8 + 24	GPDTN20067
12W	8 + 36	GPDTN20068

**SPN ACRYLIC DISTRIBUTION BOARD**

(RAL - 9003 fine white texture, IP 42 - Double Door DB)

**SPN Distribution Board (Suitable for DP Incoming and SP Outgoing)**

No. of Ways	Item Code Double Door
4W	GPDSN30006
6W	GPDSN30007
8W	GPDSN30008
12W	GPDSN30009
16W	GPDSN30010



**TPN ACRYLIC DISTRIBUTION BOARD**

(RAL - 9003 fine white texture, IP 42 - Double Door DB)



**TPN Distribution Board (Suitable for FP Incoming and SP Outgoing)**

No. of Ways	I/C + O/G Ways	Item Code Single Door
4W	4 + 12	GPDTN30006
4W	8 + 12	GPDTN30007
6W	8 + 18	GPDTN30008
8W	8 + 24	GPDTN30009
12W	8 + 36	GPDTN30010

## TPN VERTICAL DISTRIBUTION BOARD

(In accordance with IS 13032, IS 8623, IEC / BSEN 61439-3)  
RAL - 9003 fine white texture, IP 42 - Double Door DB



### TPN Vertical Distribution Board (Suitable for FP Incoming & SP / TP Outgoing)

No. of Ways	I/C + O/G Ways	Item Code Double Door
4W	8 + 12	GPDTN20069
6W	8 + 18	GPDTN20070
8W	8 + 24	GPDTN20071
12W	8 + 36	GPDTN20072

## TPN PPI HORIZONTAL DISTRIBUTION BOARD

(In accordance with IS 13032, IS 8623, IEC / BSEN 61439-3)  
RAL - 9003 fine white texture, IP 42 - Double Door DB

### TP&N Distribution Board, Per Phase Isolated Neutral (Suitable for FP Incoming and SP Outgoing)

No. of Ways	I/C + O/G Ways	Item Code Double Door
4W	8 + 6 + 12	GPDTN20077
6W	8 + 6 + 18	GPDTN20078
8W	8 + 6 + 24	GPDTN20079
12W	8 + 6 + 36	GPDTN20080



## TPN PPI VERTICAL DISTRIBUTION BOARD

(In accordance with IS 13032, IS 8623, IEC / BSEN 61439-3) RAL - 9003 fine white texture, IP 42 - Double Door DB



### TP&N Distribution Board, Per Phase Isolated Neutral (Suitable for FP Incoming and SP Outgoing)

I/C + O/G Ways	No. of Ways	Item Code Double Door
8 + 6 + 12	4W	GPDTN20046
8 + 6 + 18	6W	GPDTN20047
8 + 6 + 24	8W	GPDTN20048
8 + 6 + 36	12W	GPDTN20049

### TPN DISTRIBUTION BOARD, 7 SEGMENT

(In accordance with IS 13032, IS 8623, IEC / BSEN 61439-3)

RAL - 9003 fine white texture, IP 42 - Double Door DB



#### Suitable for FP Incoming and SP Outgoing with Provision of DP RCCB Protection

I/C + O/G Ways	No. of Ways	Item Code Double Door
8 + 6 + 12	4W	GPDTN20073
8 + 6 + 18	6W	GPDTN20074
8 + 6 + 24	8W	GPDTN20075
8 + 6 + 36	12W	GPDTN20076

### TPN DISTRIBUTION BOARD, 8 SEGMENT

(In accordance with IS 13032, IS 8623, IEC /

BSEN 61439-3)RAL - 9003 fine white texture, IP 42 - Double Door DB

#### Suitable for FP Incoming and SP Outgoing with Provision of DP RCCB Protection

No. of Ways	Item Code Double Door
4W	GPDTN20083
6W	GPDTN20084
8W	GPDTN20085
12W	GPDTN20086



### FLEXY TIER DISTRIBUTION BOARD

Flexibility of choosing Incomer & Outgoing as per your requirement,

RAL - 9003 fine white texture, IP 42 - Double Door DB



#### Distribution Board, With Total Installation Flexibility

No. of Modules	No. of Ways	Item Code Double Door
2 Row of 12 Mod	24	GPDTN20052
3 Row of 12 Mod	36	GPDTN20053
4 Row of 12 Mod	40	GPDTN20054
4 Row of 12 Mod	56	GPDTN20055

## TPN PHASE SELECTOR (VERTICAL)

(In accordance with IS 13032, IS 8623, IEC / BSEN 61439-3)  
RAL - 9003 fine white texture, IP 42 - Double Door DB



### Suitable for 8 Way Incomer and SP Outgoing with Rotary Switches (Manual Operated)

Selector Rating	No. of Ways	Item Code Double Door
40A	4 Way	GPDTN30021
40A	4 Way	GPDTN30021
40A	6 Way	GPDTN30023
63A	6 Way	GPDTN30024
40A	8 Way	GPDTN30025
63A	8 Way	GPDTN30026

## TV TEL DISTRIBUTION BOARD

(In accordance with IS 13032, IS 8623, IEC / BSEN 61439-3) RAL - 9003 fine white texture, IP 42 - Double Door DB



### SPN Distribution Board (Suitable for DP Incoming and SP Outgoing)

No. of Ways	Item Code Double Door
6W	GPDSN40001
8W	GPDSN40002
12W	GPDSN40003
16W	GPDSN40004

### TPN Distribution Board (Suitable for FP Incoming and SP Outgoing)

No. of Ways	Item Code Double Door
4W	GPDTN40001
6W	GPDTN40002
8W	GPDTN40003
12W	GPDTN40004

TV Telephone DB Part



DISTRIBUTION BOX - CLIQ

FEATURES

- Polycarbonate transparent cover
- IP 42 protection
- Incoming power source indicator
- Press to open lock
- Ready to use DB
- Cement spill protector



**Polyshield CLIQ**  
SPN Consumer Distribution Board

No. of Ways	NOS OF MCB	CODE
6W	I/C +O/G : 6	GPDSN50007
8W	I/C +O/G : 8	GPDSN50008
12W	I/C +O/G : 12	GPDSN50009
16W	I/C +O/G : 16	GPDSN50010

## DISTRIBUTION BOX – DECOUR

### FEATURES

- Fresh look
- Easy to use
- Raised neutral link
- Earthing Bolt
- Raised earthing link
- Detachable top and bottom plate
- Level marks for providing indication for fitment
- Knock-out available on all 4 sides
- Cement spill protector
- Metallic adjustable din rail
- IS 13032, IS 8623, IEC / BSEN 61439 – 3
- IP 43 protection
- Suitable for flush and surface mounting



## SPN DISTRIBUTION BOARD, DECOUR – WOODEN TEXTURE

(In accordance with IS 13032, IS 8632, IS 8623, IED / BSEN 61439-3)  
RAL - 9003 wooden texture, IP 43 - Double Door DB



### SPN Decour Distribution Board (Suitable for DP Incoming and SP Outgoing)

No. of Ways	Item Code Double Door
4W	GPDSN29D11
6W	GPDSN29D12
8W	GPDSN29D13
12W	GPDSN29D14
16W	GPDSN29D15

## TPN DISTRIBUTION BOARD, DECOUR – WOODEN TEXTURE

(In accordance with IS 13032, IS 8632, IS 8623, IED / BSEN 61439-3)  
RAL - 9003 wooden texture, IP 43 - Double Door DB



### TPN Decour Distribution Board (Suitable for FP Incoming and SP Outgoing)

No. of Ways	I/C + O/G Ways	Item Code Double Door
4W	8 + 12	GPDTN29D41
6W	8 + 18	GPDTN29D42
8W	8 + 24	GPDTN29D43
12W	8 + 36	GPDTN29D44

**SPN DISTRIBUTION BOARD,  
DECOUR - GOLDEN PASSION TEXTURE**

(In accordance with IS 13032, IS 8632, IS 8623, IED / BSEN 61439-3)

RAL - 9003 golden passion texture, IP 43 - Double Door DB



**SPN Decour Distribution Board  
(Suitable for DP Incoming and SP Outgoing)**

No. of Ways	Item Code Double Door
4W	GPDSN29G11
6W	GPDSN29G12
8W	GPDSN29G13
12W	GPDSN29G14
16W	GPDSN29G15

**TPN DISTRIBUTION BOARD,  
DECOUR - GOLDEN PASSION TEXTURE**

(In accordance with IS 13032, IS 8632, IS 8623, IED / BSEN 61439-3)

RAL - 9003 golden passion texture, IP 43 - Double Door DB



**TPN Decour Distribution Board  
(Suitable for FP Incoming and SP Outgoing)**

No. of Ways	I/C + O/G Ways	Item Code Double Door
4W	8 + 12	GPDTN29G41
6W	8 + 18	GPDTN29G42
8W	8 + 24	GPDTN29G43
12W	8 + 36	GPDTN29G44

**SPN DISTRIBUTION BOARD,  
DECOUR - MARBLE TEXTURE**

(In accordance with IS 13032, IS 8632, IS 8623, IED / BSEN 61439-3)

RAL - 9003 marble texture, IP 43 - Double Door DB



**SPN Decour Distribution Board  
(Suitable for DP Incoming and SP Outgoing)**

No. of Ways	Item Code Double Door
4W	GPDSN29M11
6W	GPDSN29M12
8W	GPDSN29M13
12W	GPDSN29M14
16W	GPDSN29M15

## TPN DISTRIBUTION BOARD, DECOUR - MARBLE TEXTURE

(In accordance with IS 13032, IS 8632, IS 8623, IED / BSEN 61439-3)  
RAL - 9003 marble texture, IP 43 - Double Door DB



### TPN Decour Distribution Board (Suitable for FP Incoming and SP Outgoing)

No. of Ways	I/C + O/G Ways	Item Code Double Door
4W	8 + 12	GPDTN29M41
6W	8 + 18	GPDTN29M42
8W	8 + 24	GPDTN29M43
12W	8 + 36	GPDTN29M44

## SPN DECOUR DOUBLE DOOR DB (SHEET METAL) (RAL- 9003 GREY WHITE, IP 43)



Item Code	No. of Ways	PACK (P/S/M)
GPDSN29W11	04W	01/00/006
GPDSN29W12	06W	01/00/006
GPDSN29W13	08W	01/00/006
GPDSN29W14	12W	01/00/004
GPDSN29W15	16W	01/00/004

## TPN DECOUR DOUBLE DOOR DB (SHEET METAL) (RAL- 9003 GREY WHITE, IP 43)



Item Code	No. of Ways	PACK (P/S/M)
GPDTN29W41	04W 8+12	1
GPDTN29W42	06W 8+18	1
GPDTN29W43	08W 8+24	1
GPDTN29W44	12W 8+36	1

# PROFESSIONAL LIGHTING

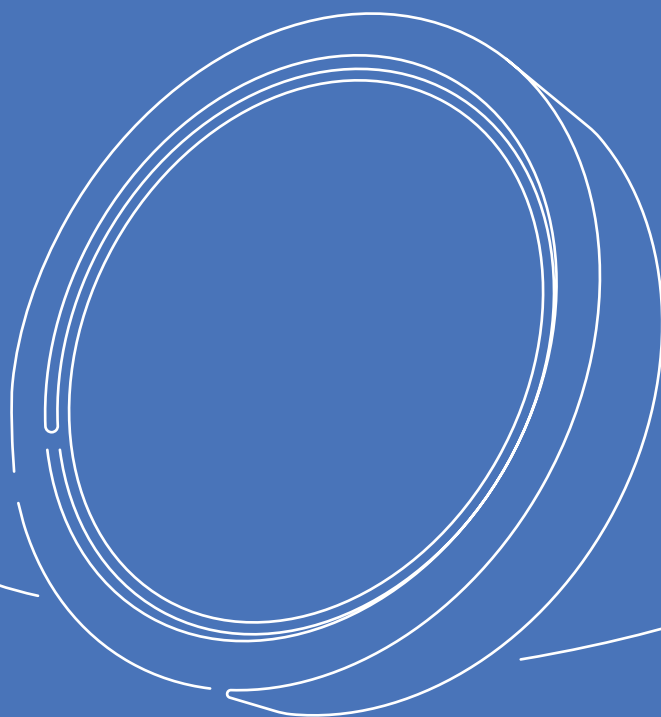

INNOVATIVE  
LIGHTING  
FOR BRIGHTER  
LIVING



## SCINTILLATE PC EDGE LIT PANEL

3W/6W/12W/15W/18W  
COOL WHITE/NEUTRAL WHITE/WARM WHITE

Beautifully clasped within a strong polycarbonate body, Scintillate Edge Lit Panel is an excellent choice for modern spaces. Easy to install and maintain, this panel is an ideal choice for any setting!

### FEATURES

- Recess mounting PC Edge Lit LED panel
- Polycarbonate housing and PS diffuser

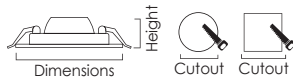

WATTS	COLOUR TEMP	DIMENSION RD/SQ LxWxH(mm)	CUT OUT RD/SQ(mm)	LM/W*	CASE LOT
3W	CW/NW/WW	Ø 90/90x90x30	Ø 65/65x65	50	20
6W	CW/NW/WW	Ø 120/120x120x30	Ø 100/100x100	60	20
12W	CW/NW/WW	Ø 170/170x170x30	Ø 150/150x150	70	20
15W	CW/NW/WW	Ø 170/170x170x30	Ø 150/150x150	75	20
18W	CW/NW/WW	Ø 225/225x225x30	Ø 198/198x198	75	20

\*6500k/cw

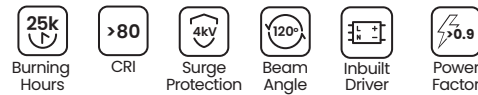

## SCINTILLATE PC FRAMELESS PANEL

6W/12W/15W/18W/24W  
COOL WHITE/NEUTRAL WHITE/WARM WHITE/3-IN-1

Scintillate Frameless Panel can be fixed directly on ceilings with minimal effort! Extremely stylish in appearance, this is a great piece of adornment when you do not have false ceilings!

### FEATURES

- Instant Start
- ABS housing & PC diffuser
- Energy efficient

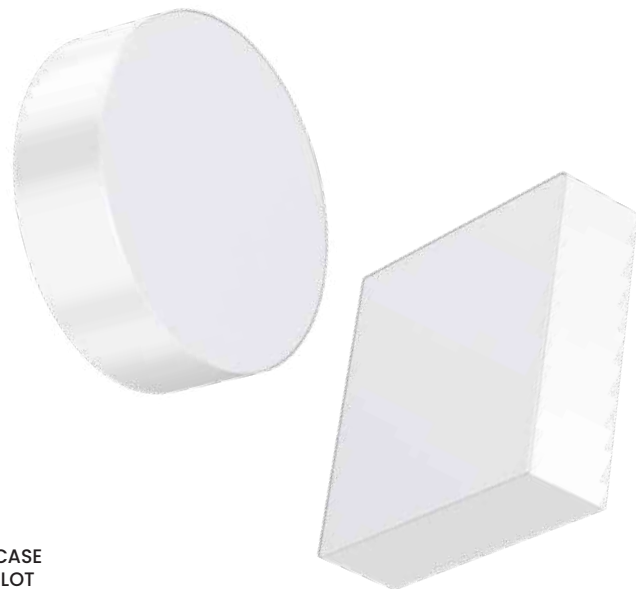

WATTS	COLOUR TEMP	DIMENSION RD/SQ LxWxH(mm)	CUT OUT RD/SQ(mm)	LM/W*	CASE LOT
6W	CW/NW/WW	Ø 90/90x90x27	NA	70	30
12W	CW/NW/WW	Ø 120/120x120x27	NA	65	20
15W	CW/NW/WW	Ø 155/155x155x27	NA	75	20
<b>NEW</b> 15W	CW-NW-WW(3-IN-1)	Ø 155/155x155x27	NA	80	20
18W	CW/NW/WW	Ø 155/155x155x27	NA	70	20
24W	CW/NW/WW	Ø 190/190x190x27	NA	70	20

\*6500k/cw

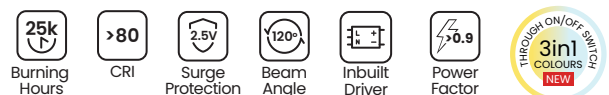

## SLIMGLO LED JUNCTION BOX DOWNLIGHT

3W/6W/12W

COOL WHITE/NEUTRAL WHITE/WARM WHITE/AMBER BLUE/GREEN/PINK/RED

The SlimGlo LED Junction Box is a versatile and energy efficient downlight suitable for diverse applications. Its straight forward installation ensures an ideal ambiance for every occasion.

### FEATURES

- Instant start
- ABS housing & PC diffuser
- Energy efficient

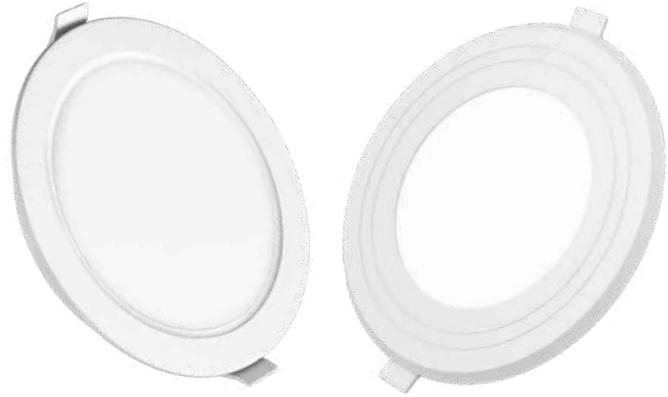
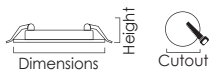

3W/6W COOL WHITE

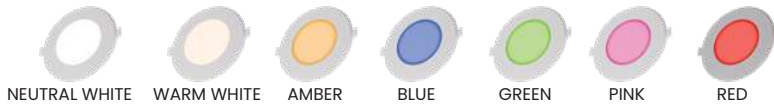

WATTS	COLOUR TEMP	DIMENSION RD/SQ LxWxH(mm)	CUT OUT RD/SQ(mm)	LM/W*	CASE LOT
3W	CW/NW/WW/AM/BL/GR/PN/RE	Ø 82x26	Ø 55	100	40
6W	CW/NW/WW/AM/BL/GR/PN/RE	Ø 110x26	Ø 71	100	40
12W	CW/NW/WW	Ø 129x30	Ø 100	100	20

\*6500K/cw



## SCINTILLATE STRIKER

3W/6W

COOL WHITE/WARM WHITE/BLUE/RED/PINK/GREEN

Add a touch of drama by creating a space of visual interest. Adorn your cabinets with beautiful colors of light with Scintillate Striker.

### FEATURES

- Energy-saving surface light suitable for indoor applications like cabinets, shelves and wardrobes

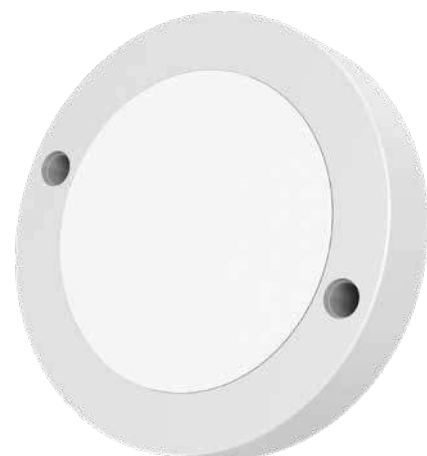

WATTS	COLOUR TEMP	DIMENSION RD/SQ LxWxH(mm)	CUT OUT RD/SQ(mm)	LM/W*	CASE LOT
3W	CW/WW/BL/GR/PN/RE	Ø 68x16	NA	NA	100
6W	CW/WW/BL/GR/PN/RE	Ø 88.64x16	NA	NA	100

\*6500K/cw

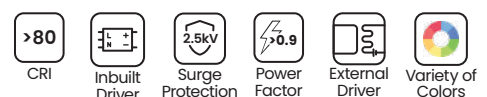

## DUAL COLOR LED ADJUSTABLE PANEL

8W/12W

COOL WHITE+AMBER/GREEN/ICE BLUE/PINK/RGB

Switch between variety of colours with warm and cool light effortlessly with our Dual Colour LED Adjustable Panel. Designed to suit every mood or task, this panel offers adjustable lighting to create the perfect atmosphere.

### FEATURES

- Optimized LED orientation for better light distribution
- High efficiency thermal design for better heat dissipation
- Operating temperature -10°C to 45°C
- No harmful UV/IR radiation and mercury free

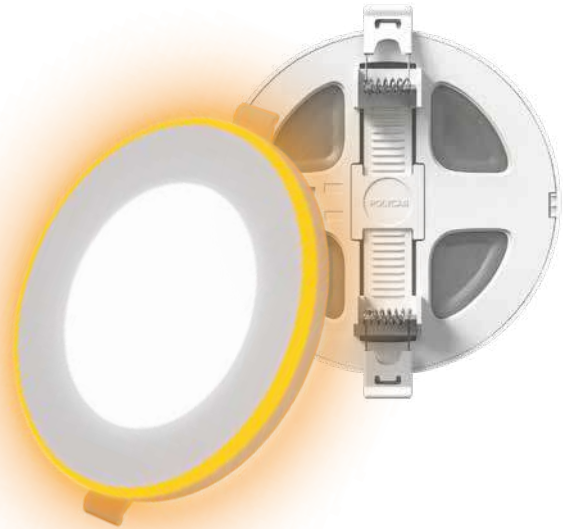

WHITE + AMBER

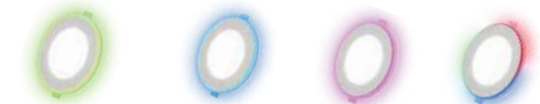

WHITE + GREEN    WHITE + ICE BLUE    WHITE + PINK    WHITE + RGB

WATTS	COLOUR TEMP	DIMENSION RD/SQ LxWxH(mm)	CUT OUT RD/SQ(mm)	LM/W*	CASE LOT
8W	CW+AM/GR/IB/PN/RGB	Ø 110x32	Ø 60-80	80	20
12W	CW+AM/GR/IB/PN/RGB	Ø 170x32	Ø 75-130	90	20

\*6500K/CW

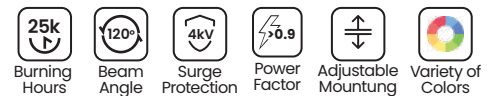

## PEARL LED SWIVEL SPOT

3W/6W/9W/12W

COOL WHITE/NEUTRAL WHITE/WARM WHITE/3-IN-1

Accentuate your decor beautifully. Choose from a variety of wattages as per your requirement. A narrow beam that can be seamlessly moved at a desired angle puts the spot exactly where you need!

### FEATURES

- Recess mounting swivel LED spot with PC body
- Energy efficient
- Operating temperature -10°C to 45°C
- No harmful UV/IR radiation and mercury free



WATTS	COLOUR TEMP	DIMENSION LxWxH(mm)	CUT-OUT SIZE(mm)	LM/W*	MRP ₹	CASE LOT
3W	CW/NW/WW	Ø 74.8x43	Ø 55	75	390	20
6W	CW/NW/WW	Ø 94.6x46	Ø 67	80	490	20
<b>NEW</b> 6W	CW-NW-WW(3-IN-1)	Ø 117x55	Ø 92	75	650	20
9W	CW/NW/WW	Ø 117x55	Ø 92	80	690	20
12W	CW/NW/WW	Ø 139.2x60	Ø 115	80	890	20

\*6500K/CW

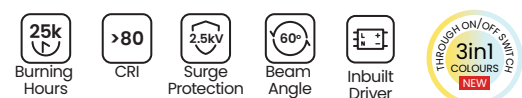

## INTENSO HIGH WATTAGE BATTEN

24W/30W/36W/40W

COOL WHITE/NEUTRAL WHITE/WARM WHITE

Experience the elegance of our LED Batten, thoughtfully designed to complement any décor. Enjoy a maintenance-free solution that delivers exceptional luminosity, energy efficiency, and long-lasting durability, enhancing your space with effortless style.

### FEATURES

- Optimized LED orientation for better light distribution
- Integrated constant current driver
- Wide shape of diffuser to ensure maximum coverage
- No harmful UV/IR radiation and mercury free



WATTS	COLOUR TEMP	DIMENSION LxWxH(mm)	LM/W*	CASE LOT
24W	CW/NW/WW	1130x23x37	100	20
30W	CW/NW/WW	1180x32x36.5	100	20
<b>NEW</b> 36W	CW/NW/WW	1180x32x36.5	100	20
40W	CW/NW/WW	1180x23x37	100	20

\*6500K/CW

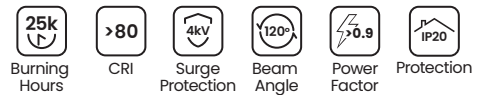

## NEO SLIM BATTEN

20W (2 FT)

COOL WHITE/WARM WHITE/NEUTRAL WHITE

The NEO Slim Batten features a sleek, slim design that adds a touch of elegance to any space. More energy efficient than conventional lighting, it helps reduce electricity bills while providing superior performance.

### FEATURES

- Optimized LED orientation for better light distribution
- Integrated constant current driver
- Operating temperature range -10°C to 45°C
- Diffuser round shape ensure maximum coverage
- No harmful UV/IR radiation and mercury free

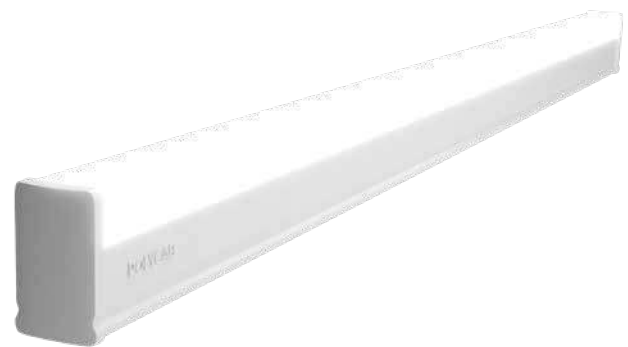

WATTS	COLOUR TEMP	DIMENSION LxWxH(mm)	LM/W*	CASE LOT
20W (2 FT)	CW/NW/WW	595x24x33	100	20

\*6500K/CW

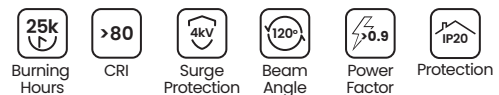

## LINEAR PROFILE LIGHTING SOLUTIONS

Suspended / Surface Mounted

Well finished seamless design with extruded aluminium housing 55 mm width, suspended/ surface mounted linear profile luminaire with efficacy 110lm/w. Best solution for open office spaces.

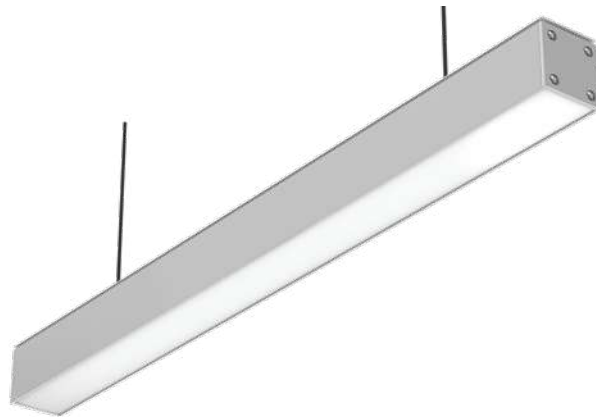

ITEM DESCRIPTION	WATTAGE	CCT
PCSLP 28W LED WH 4ft	28W	5700k
PCSLP 28W LED NW 4ft	28W	4000k
PCSLP 36W LED WH 4ft	36W	5700k
PCSLP 36W LED NW 4ft	36W	4000k
PCSLP 2x28W LED WH 8ft	56W	5700k
PCSLP 2x28W LED NW 8ft	56W	4000k

## LINEAR PROFILE LIGHTING SOLUTIONS

Recess Mounted

Well finished seamless design with extruded aluminium housing 55 mm width, Recess mounted linear profile luminaire with efficacy 110 lm/w. Best solution for modern office spaces.



ITEM DESCRIPTION	WATTAGE	CCT
PCRLP 28W LED WH 4ft	28W	5700k
PCRLP 28W LED NW 4ft	28W	4000k
PCRLP 36W LED WH 4ft	36W	5700k
PCRLP 36W LED NW 4ft	36W	4000k
PCRLP 2x28W LED WH 8ft	56W	5700k
PCRLP 2x28W LED NW 8ft	56W	4000k

## LINEAR TROFFER

Recess

CRCA housing recess mounted 1ft x 4ft linear troffer suitable for open offices, hospitals and educational institutions.



ITEM DESCRIPTION	WATTAGE	CCT
PCGLL 1x4 36 57	36W	5700k

Also available in nw



FLOOD LIGHTING

## LINEAR TROFFER

Surface

CRCA housing surface mounted 1ft x 4ft linear troffer suitable for open offices, hospitals and educational institutions.



ITEM DESCRIPTION	WATTAGE	CCT
PCGLS 1x4 36 57	36W	5700k

Also available in nw

## FULL GLOW

Troffer

2ft x 2ft recess mounted luminaire. Efficacy of 100 lm/w having deep drawn CRCA housing with opal diffuser for better light distribution and uniformity suitable for all indoor office applications



ITEM DESCRIPTION	WATTAGE	CCT
LED Deep Draw AL Frame 2x2 Panel 36W 6500K	36W	6500k
LED Deep Draw AL Frame 2x2 Panel 36W 4000K	36W	4000k

Also available in nw

# INDUSTRIAL

## INDECO PLUS

Highly efficient 150lm/w LED Highbay luminaire with pressure die-cast housing having specially designed lens optics for better distribution and uniformity with 4kv in-built surge protection. IP 66 protection including driver along with eye bolt and safety chain.

Cradle option available as per request.



ITEM DESCRIPTION	WATTAGE	CCT
PCHBHL 80W LED	80W	5700K
PCHBHL 100W LED	100W	5700K
PCHBHL 120W LED	120W	5700K
PCHBHL 150W LED	150W	5700K
PCHBHL 200W LED	200W	5700K

## INDECO

Highly efficient 120lm/w LED highbay luminaire with pressure die-cast housing having specially designed lens optics for better distribution and uniformity, with PC diffuser. Equipped with 4 kV in-built surge protection & IP 66 protection rating.

Cradle option available as per request



ITEM DESCRIPTION	WATTAGE	CCT
PCHB 80W	80W	5700k
PCHB 100W	100W	5700K
PCHB 120W	120W	5700K
PCHB 150W	150W	5700K
PCHB 200W	200W	5700K
PCHB 250W	250W	5700K

## WELL GLASS

LED well glass with pressure die cast housing with clear diffuser IP 66 protection with eye bolt for mounting

Cradle option available as per request



ITEM DESCRIPTION	WATTAGE	CCT
PCGLWG C7 30 57	30W	5700K
PCGLWG C7 35 57	35W	5700K
PCGLWG C7 40 57	40W	5700K
PCGLWG C7 60 57	60W	5700K
PCGLWG C7 70 57	70W	5700K

## INDIRAY

Corrosion and weather proof IP 66 LED batten luminaire with >110 lm/w with 4 kV in-built surge protection suitable for surface and suspended mounting.

ITEM DESCRIPTION	WATTAGE	CCT
PCWBPB 40W LED CW	40W	6500k

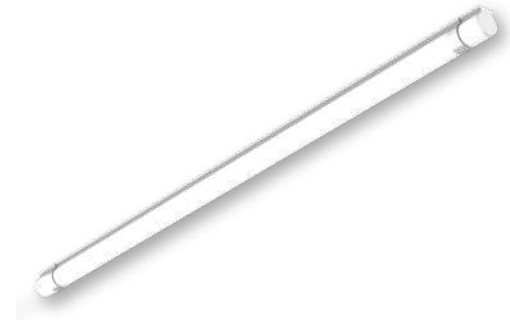

## IP 66 BATTEN WITH TUBE

Corrosion and weather proof IP 66 LED batten luminaire with separate LED tube 100 lm/w suitable for surface and suspended mounting.

ITEM DESCRIPTION	WATTAGE	CCT
PCGLPC118	1x18W	6500K
PCGLPC218	2x18W	6500K



## IP 65 LED BULK HEAD

LED bulk head with pressure die cast aluminium housing with opal diffuser, IP 65 protection.



ITEM DESCRIPTION	WATTAGE	CCT
PCGLPC118	1x18W	6500K
PCGLPC218	2x18W	6500K

## LED BULKHEAD

10W/20W

COOL WHITE/NEUTRAL WHITE/WARM WHITE

Solid choice for durability with 120-degree beam angle for wide coverage and are built to withstand dust and water with an IP65 protection making them perfect for outdoor use.



WATTS	COLOUR TEMP	DIMENSION LxWxH(mm)	POLE DIA(mm)	LM/W*	CASE LOT
10W	CW/NW/WW	170x68x46	NA	90	20
20W	CW/NW/WW	210x97x57	NA	100	20

\*6500K/CW



## STOUT

LED pit light with pressure die cast aluminum, robust design with IP 67 protection, 3 directional light with clear diffuser.

ITEM DESCRIPTION	WATTAGE	CCT
PCLPL 16W 48V AC	16W	5700k

Also available in 24V DC and 110V DC



## CLEAN ROOM

IP 54 bottom openable LED clean room fitting suitable for 10,000 and 1,00,000 class, CRCA housing & metal frame with PMMA diffuser

ITEM DESCRIPTION	WATTAGE	CCT
PCBOCLR 20W LED WH	20W	5700K
PCBOCLR 36W LED WH	36W	5700K
PCBOCLR 45W LED WH	45W	5700K



## CLEAN ROOM

IP 54 2ft x 2ft top openable LED clean room fitting suitable for class 10,000 to class 1, CRCA housing & metal frame with PMMA diffuser

ITEM DESCRIPTION	WATTAGE	CCT
PCTOCLR 20W LED WH	20W	5700K
PCTOCLR 36W LED WH	36W	5700K
PCTOCLR 45W LED WH	45W	5700K



## FLAME PROOF WELL GLASS

IP 66, integrated flame proof well glass, pressure die cast housing. Suitable for gas/vapour discharge class IIA and IIB

ITEM DESCRIPTION	WATTAGE	CCT
PCGLWG C7 45 57 FLP	45W	5700K
PCGLWG C7 60 57 FLP	60W	5700K
PCGLWG C7 100 57 FLP	100W	5700K



# STREET LIGHT

## CITISHINE

Highly efficient LED street light with 135lm/w having pressure die-cast housing, polycarbonate lens optics. IP 66 protection including driver, best solution for NHA1 with high pole spacing. Equipped with 4kv internal & 10kv external surge protection.

ITEM DESCRIPTION	WATTAGE	CCT
PCCSSL 90W LED 57k	90W	5700K
PCCSSL 120W LED 57k	120W	5700K
PCCSSL 150W LED 57k	150W	5700K
PCCSSL 200W LED 57k	200W	5700K
PCCSSL 250W LED 57k	250W	5700K
PCCSSL 280W LED 57k	280W	5700k
PCCSSL 300W LED 57k	300W	5700K



## CITIRAYS V3

IP 66 LED street light with 120lm/w having pressure die-cast housing, with polycarbonate lens optics for better distribution, 4kv internal and 10kv external surge protection.

ITEM DESCRIPTION	WATTAGE	CCT
PCGLS C4 25W 57K - V3	25W	5700K
PCGLS C4 30W 57K - V3	30W	5700K
PCGLS C4 35W 57K - V3	35W	5700k
PCGLS C4 45W 57K - V3	45W	5700K



## CITIRAYS V3

IP 66 LED street light with 120lm/w having pressure die-cast housing, with polycarbonate lens optics for better distribution, 4kv internal and 10kv external surge protection.

ITEM DESCRIPTION	WATTAGE	CCT
PCGLS C4 60W 57K - V3	60W	5700K
PCGLS C4 72W 57K - V3	72W	5700K
PCGLS C4 90W 57K - V3	90W	5700K
PCGLS C4 120W 57K - V3	120W	5700K
PCGLS C4 150W 57K - V3	150W	5700K



## CITIRAYS V3

IP 66 LED street light with 120lm/w having pressure die-cast housing, polycarbonate lens optics for better distribution, 4kv internal and 10kv external surge protection .

ITEM DESCRIPTION	WATTAGE	CCT
PCGLS C4 200W 57K - V3	200W	5700K
PCGLS C4 250W 57K - V3	250W	5700K
PCGLS C4 280W 57K - V3	280W	5700k



## CITIRAYS C4

IP 66 LED street light with 120lm/w having pressure die-cast housing, secondary lens and toughened glass cover, 4kv internal and 10kv external surge protection. Best solution for B1 and B2 category road illumination.

ITEM DESCRIPTION	WATTAGE	CCT
PCGLS C4 30W 57K	30W	5700K
PCGLS C4 45W 57K	45W	5700K



## CITIRAYS C4

IP 66 LED street light with 120lm/w having pressure die-cast housing, secondary lens and toughened glass cover, 4kv internal and 10kv external surge protection. Best solution for B1 and B2 category road illumination.

ITEM DESCRIPTION	WATTAGE	CCT
PCGLS C4 60W 57K	60W	5700K
PCGLS C4 72W 57K	72W	5700K
PCGLS C4 90W 57K	90W	5700K
PCGLS C4 120W 57K	120W	5700K
PCGLS C4 150W 57K	150W	5700K
PCGLS C4 200W 57K	200W	5700K
PCGLS C4 250W 57K	250W	5700K





**FACADE LIGHTING**

## CITIRAYS

Dusk to Dawn

Next generation LED street light with pressure die-cast housing, high performance polycarbonate optics and IP66 ingress protection. 4kV inbuilt surge protection with Top opening driver cover for easy maintenance. Efficacy 100 lm/w.



ITEM DESCRIPTION	WATTAGE	CCT
PCGLS SL 35W (IL)	35W	5700K
PCGLS SL 45W (IL)	45W	5700K

## AGLOW LED STREET LIGHT

24W/36W/50W

COOL WHITE/NEUTRAL WHITE/WARM WHITE

Transform your outdoor spaces with Aglow LED Street Light, designed for powerful and consistent illumination. With IP65 water resistance, it withstands all weather conditions. Ideal for year-round use, ensuring durability and consistent brightness. Enhance safety and visibility in any environment with ease.



WATTS	COLOUR TEMP	DIMENSION LxWxH(mm)	POLE DIA(mm)	LM/W*	CASE LOT
24W	CW/NW/WW	272x120x57	Ø 40	100	12
36W	CW/NW/WW	310x136x57	Ø 40	100	8
50W	CW/NW/WW	351x170x57	Ø 40	100	4

\*6500k/CW

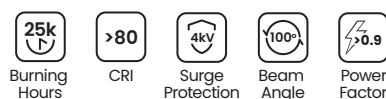

## EMBLAZE LED STREET LIGHT

24W/36W/50W

COOL WHITE/NEUTRAL WHITE/WARM WHITE

Transform your urban landscape with powerful and effective lighting. Built with a sturdy fixture and IP65 water resistance, it stands strong in all weather conditions. Ideal for outdoor spaces, it ensures durability and consistent brightness. Perfect for year-round illumination.



WATTS	COLOUR TEMP	DIMENSION LxWxH(mm)	POLE DIA(mm)	LM/W*	CASE LOT
24W	CW/NW/WW	325x87x105	Ø 40	100	12
36W	CW/NW/WW	345x87x105	Ø 40	100	8
50W	CW/NW/WW	660x100x105	Ø 40	100	4

\*6500k/CW



## OUTDOOR TRI COLOR LED STRIP

IP 65 tri color (Tiranga) LED rope for outdoor applications like lighting pole beautification, Monuments, residential/hotels beautification. 18 mtr roll with 120 no. of LED per meter having combination of saffron, white and green colour.

ITEM DESCRIPTION	WATTAGE	CCT
PCLTCRO 120 18M IP 65	10W/Mtr (18x10=180mtr)	TRI COLOR COMBINATION



## ECO

110lm/w LED floodlight luminaire with pressure die-cast housing, toughened glass cover. IP 66 protection including driver, 4kv internal and 10kv external surge protection.

ITEM DESCRIPTION	WATTAGE	CCT
PCGLF 60W 57K	60W	5700K
PCGLF 120W 57K	120W	5700K
PCGLF 150W 57K	150W	5700K
PCGLF 200W 57K	200W	5700K



## CITIBEAM

120lm/w LED floodlight luminaire with pressure die-cast housing having IP Lens optics with IP 66 protection including driver, 4 kV in-built and 10 kV external surge protection.

ITEM DESCRIPTION	WATTAGE	CCT
PCFSL 60W	60W	5700K
PCFSL 80W	80W	5700K
PCFSL 100W	100W	5700
PCFSL 120W	120W	5700K
PCFSL 150W	150W	5700KK



## CITIBEAM

120lm/w LED floodlight luminaire with pressure die-cast housing having IP lens optics with IP 66 protection including driver, 4 kV in-built and 10 kV external surge protection.

ITEM DESCRIPTION	WATTAGE	CCT
PCFSL 200W	200W	5700K



## ESTABLE

120lm/w LED floodlight luminaire with pressure die-cast housing having toughened glass cover with secondary lens optics, IP 66 protection including driver, 4 kV in-built and 10 kV external surge protection.

ITEM DESCRIPTION	WATTAGE	CCT
PCGLF C5 01 80W	80W	5700K
PCGLF C5 01 100W	100W	5700K
PCGLF C5 01 120W	120W	5700K
PCGLF C5 01 150W	150W	5700K
PCGLF C5 01 200W	200W	5700K
PCGLF C5 01 250W	250W	5700K
PCGLF C5 01 300W	300W	5700K
PCGLF C5 01 350W	350W	5700K
PCGLF C5 01 400W	400W	5700K



## ESTABLE

140lm/w LED floodlight luminaire with pressure die-cast housing having toughened glass cover with secondary lens optics, IP 66 protection including driver, 4 kV in-built and 10 kV external surge protection.



ITEM DESCRIPTION	WATTAGE	CCT
PCGLF C5 01 500W	500W	6500k

## ESTABLE

140lm/w LED floodlight luminaire with pressure die-cast housing having toughened glass cover with secondary lens optics, IP 66 protection including driver, 4 kV in-built and 10 kV external surge protection.



ITEM DESCRIPTION	WATTAGE	CCT
PCGLF C5 01 1000W	1000W	6500k
PCGLF C5 01 1500W	1500W	6500k
PCGLF C5 01 1800W	1800W	6500k

## GLEER LED FLOOD LIGHT



30W/50W/100W  
COOL WHITE/NEUTRAL WHITE/WARM WHITE

Sleek design meets high durability, this light provides perfect illumination. Its IP66 weatherproof rating and 4.0 kV surge protection ensure reliable performance in harsh conditions, making it ideal for both residential and commercial use year-round.



WATTS	COLOUR TEMP	DIMENSION LxWxH(mm)	POLE DIA(mm)	LM/W*	CASE LOT
30W	CW/NW/WW	185x215x42	NA	100	8
50W	CW/NW/WW	185x215x42	NA	100	8
100W	CW/NW/WW	265x278x42	NA	100	4

\*6500k/cw

-   
 25k  
 Burning Hours
-   
 >80  
 CRI
-   
 4kV  
 Surge Protection
-   
 90°  
 Beam Angle
-   
 >0.9  
 Power Factor



**GARDEN LIGHTING**

## BOLLARDS

800 mm conical shape LED bollard with opal acrylic diffuser and IP 65 protection.

ITEM DESCRIPTION	WATTAGE	CCT
LED Bollard 12W 800mm WW - GL 17503	12W	3000K
LED Bollard 12W 800mm CW- GL 17503	12W	6500K

Decorative bollard with opal acrylic diffuser and IP 65 protection.

ITEM DESCRIPTION	WATTAGE	CCT
LED Bollard Fixture - GL 11407	12W	3000K



## CYLINDRICAL BOLLARDS

A simple and sleek in design and uniform curves with functional appearance making it popular choice in all kind of commercial and residential landscape spaces.

ITEM DESCRIPTION	WATTAGE	CCT
PCGLBH2 01 10 X - 600 MM WW	10W	3000K
PCGLBH2 01 10 X - 600 MM CW	10W	6500K



## LED POST TOP LANTERN

Sophisticated product solution that combines modern aesthetics with functional illumination, featuring frosted glass and acrylic diffuser evenly to create a soft ambient glow, making them ideal for various outdoor spaces with style.

ITEM DESCRIPTION	WATTAGE	CCT
PCGLPTH 45W LED WW	45W	3000K
PCGLPTH 45W LED CW	45W	6500K



## LED POST TOP LANTERN

Sophisticated product solution that combines modern aesthetics with functional illumination, featuring frosted glass and acrylic diffuser evenly to create a soft ambient glow, making them ideal for various outdoor spaces with style.

ITEM DESCRIPTION	WATTAGE	CCT
PCGLPT 01 25 O	25W	6500K
PCGLPT 01 25 C	25W	6500K
PCGLPT 01 40 O	40W	6500K
PCGLPT 01 40 C	40W	6500K



## POST TOP

IP 65 LED post top with decorative circular design with polycarbonate opal diffuser.

ITEM DESCRIPTION	WATTAGE	CCT
PCGLPT 45W LED WW	45W	3000K
PCGLPT 45W LED CW	45W	6500K

Vintage design IP 65 post top aesthetically well designed with acrylic diffuser.

ITEM DESCRIPTION	WATTAGE	CCT
PCGLPT 30W LED WW ARCHI	30W	3000K
PCGLPT 30W LED CW ARCHI	30W	6500K

IP 65 decorative classic design LED post top having aluminium housing with frosted diffuser.

ITEM DESCRIPTION	WATTAGE	CCT
PCGLPT 30W LED CDL DECO	30W	6500K
PCGLPT 30W LED WW DECO	30W	3000K



## VIGARO CLEAR LED GATE LIGHT

20W  
COOL WHITE/NEUTRAL WHITE/WARM WHITE

The Vigaro Clear LED Gate Light, made of high-grade polycarbonate, IP65 waterproof-tested and 360-degree beam angle provides perfect illumination for home gates or compounds, enhancing your home's appearance.

WATTS	COLOUR TEMP	DIMENSION LxWxH(mm)	POLE DIA(mm)	LM/W*	CASE LOT
20W	CW/NW/WW	175x175x 225	Ø 40	70	4

\*6500K/CW



## VIGARO OPAL LED GATE LIGHT

24W  
COOL WHITE/NEUTRAL WHITE/WARM WHITE

Illuminate your entrance with style and durability. Featuring IP65 water resistance and a 360-degree beam angle, this LED gate light offers reliable, radiant lighting that enhances both beauty and functionality in any weather.

WATTS	COLOUR TEMP	DIMENSION LxWxH(mm)	POLE DIA(mm)	LM/W*	CASE LOT
24W	CW/NW/WW	166x166x260	Ø 40	70	4

\*6500K/CW



# FACADE LIGHTING



An architectural facade refers to the exterior face or frontage of a building, often designed to make a visual statement or serve a functional purpose. It plays a crucial role in how a building interacts with its environment, both aesthetically and structurally. Architecture facade can be designed in many different styles, materials, and configurations depending on factors like climate, cultural context, location and the function of the building.

We understand that every building plays a role in shaping the character of a city. Our facade lighting product solutions are designed to enhance the beauty of your architecture while contributing to the overall beautification of the urban landscape. Whether you're developing a new district, refreshing a historic area, or simply improving a building's exterior, our team works with you to create lighting that complements the city's vision.

Our curated collection of architectural facade lighting is not only designed to transform individual buildings but also to elevate the entire cityscape. Whether you're illuminating a corporate headquarters, cultural landmark, or public space, our lighting solutions enhance both the beauty of your building and contribute to the overall beautification of the city. The impact of facade lighting on a building as well as its broader effect on urban spaces, creating a sense of community and citywide beautification.



## LINER WALL WASHER

Linear wall washer is a type of architectural lighting used to illuminate building exteriors, creating uniform brightness across surfaces, Polycab offering newly designed with the wide beam angle to "wash" walls with light, enhancing the building's aesthetics, visibility, and security.



## INDIRAY FOCUS LIGHT

A focus light refers to a lighting fixture designed to project a concentrated, directional beam onto a specific area or object. This can be achieved using narrow beam linear wall washers, spotlights, or floodlights with adjustable optics.



**INDIRAY ROUND FLOOD LIGHT**

A round flood light is a high-intensity lighting fixture designed to provide broad and uniform illumination over large areas. These lights are commonly used for outdoor security, architectural lighting, landscapes, and sports fields.



**INDIRAY MODULAR FLOOD LIGHT**

A modular flood light is an excellent choice for facade lighting, offering high brightness, flexibility, and energy efficiency. The modular design allows for custom wattage, beam angles, and configurations, making it perfect for highlighting architectural details on buildings, monuments, and landmarks.



**INDIRAY SPOT FACADE LIGHT**

An LED spot facade light is a narrow-beam, high-intensity lighting fixture used to highlight architectural details of building exteriors. Unlike wall washers, which provide broad illumination, spotlights focus light on specific elements such as columns, statues, logos, or textured surfaces.



**FACADE UP LIGHTER**

A facade up lighter is a powerful LED fixture designed to project light upward, emphasizing architectural features such as walls, columns, entrances, and textures. These lights are commonly used to create a dramatic and elegant nighttime appearance for buildings and landmarks.



**NEON FLEX FOR FACADE LIGHTING**

Neon flex is a versatile, energy-efficient, and flexible LED lighting solution that mimics traditional neon tubes while offering better durability, safety, and customization. It's perfect for accentuating building facades, outlining structures, and creating vibrant signage.

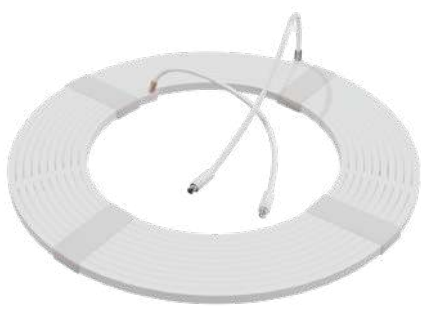

## FLEXIBLE WALL WASHER

A flexible wall washer is a bendable LED lighting solution designed to provide smooth, uniform illumination on facades, curved surfaces, and irregular architectural elements. Unlike traditional rigid wall washers, flexible versions can contour around corners, curves, and uneven surfaces, making them ideal for modern, artistic, and unconventional lighting designs.



## LINEAR GROUND BURIAL LIGHTS

Linear ground burial lights, a cutting-edge in-ground lighting solution designed for seamless integration into urban and architectural environments. These lights offer a low-profile yet powerful illumination, creating striking visual effects while maintaining a clutter-free aesthetic.



## ROUND GROUND BURIAL LIGHTS

Round ground burial lights are recessed LED fixtures designed to be installed flush with the ground, providing discreet yet powerful lighting for facades, pathways, landscapes, and architectural features. These lights offer 360° illumination, making them ideal for highlighting structures, creating guiding lights, or adding decorative accents to outdoor spaces.



## DMX SPLITTER

DMX Splitters amplify the incoming DMX signal to ensure consistent strength and reliability across multiple outputs, even over long cable runs.

Our DMX Splitters feature several output ports e.g. 2,4,6,8 etc, allowing you to connect multiple devices.

Its provides optical isolation for DMX signal, reducing risk of interference and ensuring clean signal transmission.

All systems of auto pilot work with 5/12 volt dc or 240V AC supply.

Dmx data output by 3 pin Female XLR set.



## ACCESSORIES USED IN FACADE LIGHTING INSTALLATION



3 PIN XLR CONNECTOR



MALE-FEMALE CONNECTOR



IP68 Y - CONNECTOR



IP68 T - CONNECTOR

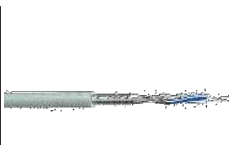

SINGLE PAIR SHIELDED DMX CABLE



IP68 I - CONNECTOR

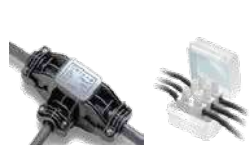

WATERPROOF GEL CONNECTOR

# FANS

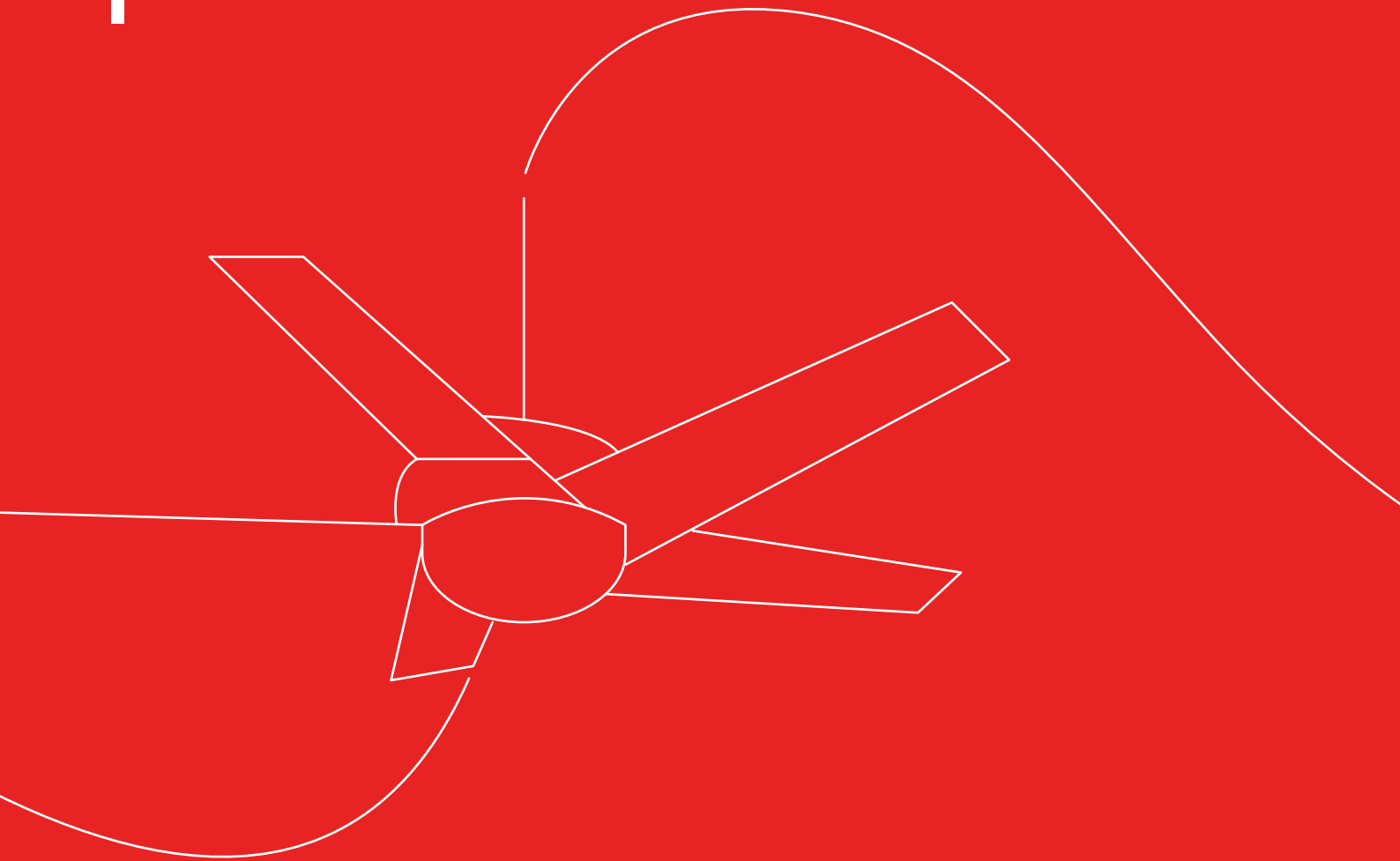



# GLAMOUR IN MOTION

Experience energy-efficient  
comfort with Advanced BLDC  
Technology.





## SILENCIO CRUISER BLDC

Sweep Size 1200 mm

With its modern design and stylish look, this fan is the perfect example of luxury. Its beautiful pattern and strong ABS body make it a great combination of new technology and simple art.

- 100% copper winding motor
- Powerful air delivery with whisper quite operation
- Diamond edge design with hawk wing blades
- Energy efficient BLDC motor
- RF point anywhere remote
- Up to 65% savings\* on electricity bill



Sweep (MM)	1200
Speed (RPM)	310
Power Input (W)	38
Air Delivery (CMM)	245

WHITE  
ROSEGOLD



## SILENCIO MINI BLDC

Sweep Size 1200mm | 900mm | 600mm

The compact yet feature-loaded fan ensures high performance, saves power with Advanced BLDC Technology and comes in a sleek, compact and contemporary design.

- Energy efficient bldc motor
- RF point anywhere remote with multi-fan pairing
- Reverse rotation mode for winters and air-conditioned rooms
- 100% copper winding motor
- Breeze, sleep and boost++ mode for enhance consumer experience
- 25 fine speed setting for selecting your accurate speed



Sweep (MM)	600 / 900 / 1200
Speed (RPM)	820 / 450 / 380
Power Input (W)	32 / 30 / 35
Air Delivery (CMM)	120 / 160 / 235

NATURAL  
WOOD



NATURAL  
WALNUT  
WOOD



PEARL  
BROWN



PEARL  
BEIGE



BIRKIN  
GOLD



COOL  
GREY



EXPRESSO  
BROWN



MATT  
WHITE



MATT  
BLACK



LUSTER  
BROWN





**ARIA 32 BLDC**

Sweep Size 1200 mm

**REGULATOR OPERATED  
BLDC CEILING FAN**

**Works with Home Fan Regulator**

- Energy efficient 100% Copper Winding motor
- Powerful BLDC Motor
- 2 Years Warranty



Sweep (MM)	1200
Speed (RPM)	350
Power Input (W)	32
Air Delivery (CMM)	225

**ZOOMER PRIME**

Sweep Size 1200mm | 900mm | 600mm

Add a touch of elegance to your interiors with this classy ceiling fan. Its premium finish brings a sophisticated aura to your room. Along with this, the rustproof aluminium blades make it durable.

- Rustproof aluminium blades
- Broad blade design
- High speed operation
- 3 years warranty



Sweep (MM)	600 / 900 / 1200
Speed (RPM)	800 / 450 / 400
Power Input (W)	70 / 48 / 53
Air Delivery (CMM)	120 / 150 / 215

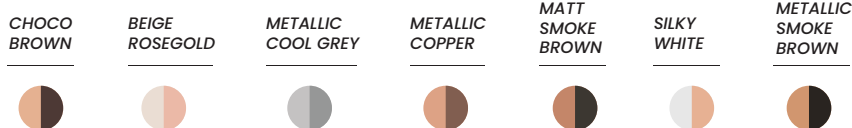

600mm available in Silky White, Choco Brown, Metallic Smoke Brown, Metallic Copper & Beige Rosegold

FRESHNER NEO



Easy To Clean



High Air Suction



Minimal Power Yet High Performance



Powerful Motor with 100% Copper Winding

WHITE

BLACK



Sweep (MM)	150/220/250
Speed (RPM)	150/220/250
Power Input (W)	22/30/35
Air Delivery (CMM)	320/500/830

AIROFRESH



Easy To Clean



High Air Suction



Minimal Power Yet High Performance



Powerful Motor with 100% Copper Winding



High Speed Operations

WHITE

STEEL



Sweep (MM)	100/150
Speed (RPM)	2600/2400
Power Input (W)	15/22
Air Delivery (CMM)	125/275

FRESHLY PRIME



-  Easy To Clean
-  High Air Suction
-  Minimal Power Yet High Performance
-  Powerful Motor with 100% Copper Winding
-  High Speed Operations
-  Thermal Overload Protector

WHITE	WOOD	STEEL
		

Sweep (MM)	150
Speed (RPM)	2300
Power Input (W)	21
Air Delivery (CMM)	300

# TPW FANS

A wide of range of Table Fans, Pedestal Fans and Wall Fans with Normal Speed and High Speed variants and plethora of colour options.

WHITE	BLACK	SKY BLUE	TURQUIOSE BLUE	BLUE
				

-  High Air Thrust
-  Minimal Power Yet High Performance
-  100% Copper Winding
-  Heavy Duty Motor
-  Aerodynamic Blades With Cutting Edge Design
-  Thermal Overload Protector



# SOLAR



# EVERYTHING UNDER THE SUN



**SOLAR PV MODULE ( DCR )**

Mono PERC Cell RANGE - 540 w

**25** Years Performance Warranty

**10** Years Product Warranty

Ideal for **Utility & Commercial** Installations

Half-Cut Cells for Lower Electrical Losses

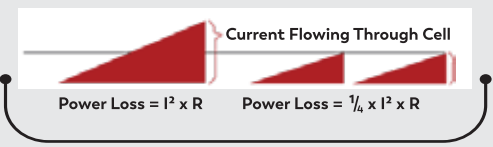
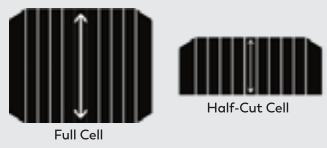

**SOLAR PV MODULE ( NON DCR )**

Mono PERC, Bifacial, Glass to Backsheet Cell RANGE - 550 wp

**25** Years Performance Warranty

**10** Years Product Warranty

Ideal for **Utility & Commercial** Installations

Non Destructive Cell Cutting for Zero Micro Cracks

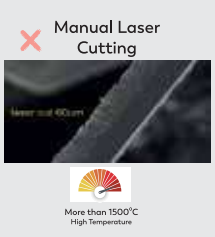

## SOLAR PV MODULE (TOP CON-NON DCR)

N-Type TOP CON, Bifacial, Glass to Backsheet  
Cell RANGE - 590wp



27 Years  
Performance  
Warranty



12 Years  
Product  
Warranty

Ideal for **Utility & Commercial**  
Installations

3.26% BOS Savings with N-Type

Project	N-Type VS P-Type Cost Comparison
Land	-3.60%
Foundation	-5.26%
Support	-4.08%
Cable	-5.71%
<b>Overall BOS Cost</b>	<b>-3.26%</b>



## SOLAR INVERTER

Models: 2 kw – 110 kw

Single phase & Three Phase

PSIT-40k-SM6

PSIT-100K-AM10

PSIT-50K-SM8

PSIT-110K-AM10

PSIT-60K-SM8



### FEATURES

- Maximum Efficiency 98.7%
- Wide Voltage Range
- Supports 50% DC overload
- 10 MPPT design with precise MPPT algorithm
- THDi < 2%, Low Harmonic Distortion
- IP66 for outdoor Installation
- Intelligent Fan Cooling
- Intelligent String Monitoring
- Smart I-V Curve Diagnosis
- Fuse free design to avoid hazard
- Type II SPD for both DC and AC side
- Integrated DC disconnect switches
- RS-485, Wi-Fi / GPRS monitoring interface
- Support "Y" type connection in DC side
- Support aluminium wire access to reduce cost
- Free remote monitoring on Web Portal and Mobile App

## POLYCAB SOLAR DC CABLE

H1Z2Z2-K BS EN 50618  
Photovoltaic Solar DC Cable,  
Halogen Free, Flame Retardant

### SALIENT FEATURES:

- Halogen free
- Electron Beam Cross-linked
- Flame Retardant
- Long Life
- Flexibility,
- UV, Ozone resistant,
- Hydrolysis resistance,
- high temperature resistance



## POLYCAB HT- CABLE

### SALIENT FEATURES:

- Polycab, with voltage grade ranging from 1.9/3.3 kV to 19/33 kV, are used for supplying power to wide networks such as commercial, industrial and urban/ residential. These cables are available with XLPE/EPR insulation and have a temperature rating of 90°C and 105°C respectively.
- The cables are halogen free, flame retardant and provide continuous load and extra protection from short circuits and fire.
- Conductor: The high conductivity annealed plain stranded compacted aluminum/copper conductor is produced in-house with highly advanced machines. at the interface between conductor and insulation. It also prevents electrical stress concentrations on the surface of the conductor.

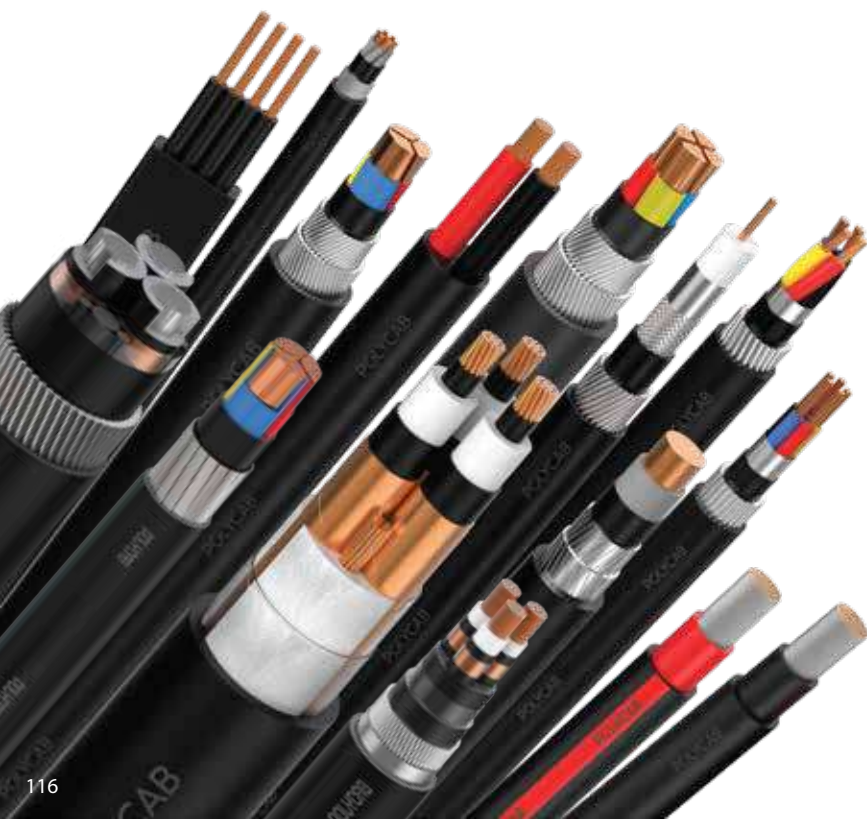

## DC & AC DISTRIBUTION BOX

### SALIENT FEATURES:

- **Ingress Protection:** IP67
- **Enclosure Type:** PC Transparent Cover with Hinge
- **Mounting:** BASE MOUNTING
- **Humidity:** 100% Non- condensing
- **Operating Conditions:** Temperature (-20 to +60) ° C
- **Type of Protections:** Short circuit, Over load & Surge Voltage protection
- **UV Resistance:** Yes
- **Compliance Standards:** IS/IEC: 60898-1, IS/IEC: 60947-2, IEC: 60947-7-1, EN: 61643-11, EN: 50 °C539-11

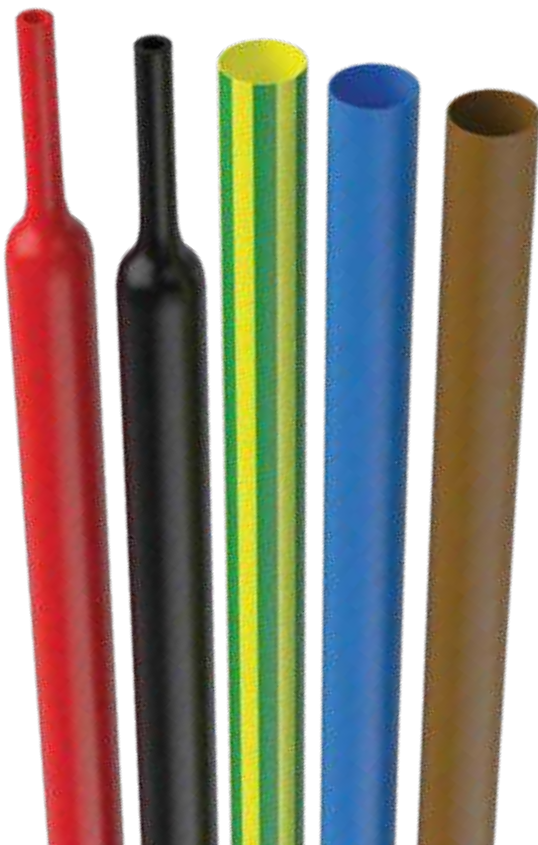

## HEAT SHRINKS

### KEY FEATURES & BENEFITS

- **Flexible Material:**  
Polyolefin allows for quick and easy installations for OEM and maintenance operations, reducing installation and assembly costs.
- **Flame Retardant:**  
Polycab's thin-walled heat shrink tubing meets UL224 VW-1 standards, ensuring high flame resistance.
- **Chemical Resistance:**  
Polyolefin resists common chemicals, fluids, and acids effectively.
- **Insulation:**  
Heat shrink tubing bars moisture and humidity; adhesive-lined variants offer superior environmental protection by melting and encapsulating the substrate
- **Market Applications:**  
White Goods/Appliances, Renewable Energy, Automotive, Electrical, Electronics

# MC4 CONNECTORS

## SPECIFICATIONS:

- **Introducing Polycab MC4 Connectors:**  
The Trusted Choice for Solar PV Connections.  
Unlock the Power of Solar Energy with Reliable Connections
- **Unrivaled Durability:**  
Crafted from high-quality materials for enduring performance in harsh environments.
- **Superior Safety:**  
Engineered to meet stringent safety standards, ensuring protection against electrical hazards.
- **Optimized Performance:**  
Low contact resistance and excellent conductivity maximize energy transfer for enhanced system efficiency.

Male-Female



Assembled





# POLYCAB

---



## CORPORATE OFFICE

### POLYCAB INDIA LIMITED

#29, The Ruby, 21<sup>st</sup> Floor, Senapati Bapat Marg, Tulsi Pipe Road, Dadar (West),  
Mumbai - 400 028, Maharashtra (India)

Ph.: +91-22-2432 7070/4, 6735 1400 | Send 'Hi' on 7304485540

---

 [enquiry@polycab.com](mailto:enquiry@polycab.com) |  1800 267 0008 |  [www.polycab.com](http://www.polycab.com)

---

## FOLLOW US ON

